



 **BINDER**  
Best conditions for your success

BINDER Industrial

Архангельск (8182)63-90-72  
Астана +7(7172)727-132  
Белгород (4722)40-23-64  
Брянск (4832)59-03-52  
Владивосток (423)249-28-31  
Волгоград (844)278-03-48  
Вологда (8172)26-41-59  
Воронеж (473)204-51-73  
Екатеринбург (343)384-55-89  
Иваново (4932)77-34-06  
Ижевск (3412)26-03-58  
Казань (843)206-01-48



Калининград (4012)72-03-81  
Калуга (4842)92-23-67  
Кемерово (3842)65-04-62  
Киров (8332)68-02-04  
Краснодар (861)203-40-90  
Красноярск (391)204-63-61  
Курск (4712)77-13-04  
Липецк (4742)52-20-81  
Магнитогорск (3519)55-03-13  
Москва (495)268-04-70  
Мурманск (8152)59-64-93  
Набережные Челны (8552)20-53-41

Нижний Новгород (831)429-08-12  
Новокузнецк (3843)20-46-81  
Новосибирск (383)227-86-73  
Орел (4862)44-53-42  
Оренбург (3532)37-68-04  
Пенза (8412)22-31-16  
Пермь (342)205-81-47  
Ростов-на-Дону (863)308-18-15  
Рязань (4912)46-61-64  
Самара (846)206-03-16  
Санкт-Петербург (812)309-46-40  
Саратов (845)249-38-78

Смоленск (4812)29-41-54  
Сочи (862)225-72-31  
Ставрополь (8652)20-65-13  
Тверь (4822)63-31-35  
Томск (3822)98-41-53  
Тула (4872)74-02-29  
Тюмень (3452)66-21-18  
Ульяновск (8422)24-23-59  
Уфа (347)229-48-12  
Челябинск (351)202-03-61  
Череповец (8202)49-02-64  
Ярославль (4852)69-52-93

сайт: [www.binder.nt-rt.ru](http://www.binder.nt-rt.ru) || эл. почта: [bri@nt-rt.ru](mailto:bri@nt-rt.ru)

# Table of contents

02	Product selection chart	
04	Standards	
06	BINDER GmbH	
	12 <b>Drying and tempering</b> 14 <b>Drying and heat treatment</b> – ED   FD   FED 28 <b>Material testing</b> – FP   M 38 <b>Vacuum drying</b> – VD   VDL 50 <b>Safety drying</b> – FDL   MDL	1
	60 <b>Environmental simulation</b> 62 <b>Alternating temperature and climate testing</b> – MK   MKT   MKF   MKFT 80 <b>Dynamic constant climate testing</b> – KMF	2
	86 <b>APT-COM™ Communication software</b>	3
	90 <b>BINDER INDIVIDUAL</b>	4

# Product selection chart

► INNER CHAMBER VOLUME AND TEMPERATURE RANGE

Application	Product	Series	Inner Chamber Volume						Temperature range
			23 liter / 0.7 cu.ft.	53 liter / 1.9 cu.ft.	115 liter / 4.1 cu.ft.	240 liter / 8.5 cu.ft.	400 liter / 14.3 cu.ft.	720 liter / 25.4 cu.ft.	
 <p>Drying and tempering Page 55</p>	Drying ovens with gravity convection	ED	●	●	●	●	●	●	T <sub>A</sub> 5 °C – 300 °C
	Drying ovens with mechanical convection	FD	●	●	●	●			T <sub>A</sub> 5 °C – 300 °C
	Heating chambers with mechanical convection	FED		●	●	●	●	●	T <sub>A</sub> 5 °C – 300 °C
	Temperature test chambers	FP		●	●	●	●	●	T <sub>A</sub> 5 °C – 300 °C
	Temperature test chambers	M		●	●	●	●	●	T <sub>A</sub> 5 °C – 300 °C
	Vacuum drying ovens	VD	●	●	●				T <sub>A</sub> 15 °C – 200 °C
	Safety vacuum drying ovens	VDL	●	●	●				T <sub>A</sub> 15 °C – 200 °C
	Safety drying ovens	FDL			●				T <sub>A</sub> 5 °C – 300 °C
	Safety drying ovens	MDL			●				T <sub>A</sub> 5 °C – 350 °C

 <p>Environmental simulation Page 55</p>	Environmental simulation chambers	MK		●	●	●		●	-40 °C – 180 °C
	Low temperature testing chambers	MKT			●	●		●	-70 °C – 180 °C
	Climate test chambers	MKF			●	●		●	-40 °C – 180 °C
	Environmental simulation chambers	MKFT			●	●		●	-70 °C – 180 °C
	Dynamic constant climate chambers	KMF			●	●		●	-10 °C – 100 °C

## ► TEMPERATURE-TIME FUNCTIONS

Series	Climate range	Temperature Fluctuation ±K	Temperature Alarm	LCD screen control with extended program functions	Ramp function	Delayed OFF	Delayed ON	Program mode	Week program functions	Viewing Window	Fan	Wasserkühlung	Interface	Temperature safety device
ED		0.3	V		●	●							RS422*	2
FD		0.3	V		●	●					●			2
FED		0.3	V		●	●	●				( )		RS422	2
FP		0.3	V		●	●	●	●	●		( )		RS422	2
M		0.3	V	●	●	●	●	●			( )		RS422	2
VD		0.1	V		●	●	●	●	●	●			RS422	2
VDL		0.1	V		●	●	●	●	●	●			RS422	2
FDL		0.3	V/A		●	●	●	●	●		●		RS422	2
MDL		0.5	V/A	●	●	●	●	●			●		RS422	2
MK		< 0.5	V/A	●	●	●	●	●		●	●		Ethernet <sup>1</sup>	2
MKT		< 0.6	V/A	●	●	●	●	●		●	●		Ethernet	2
MKF	10 – 95 °C / 10 – 98% r.H.	< 0.6	V/A	●	●	●	●	●		●	●	●	Ethernet	2
MKFT	10 – 95 °C / 10 – 98% r.H.	< 1.5	V/A	●	●	●	●	●		●	●		Ethernet	2
KMF	10 – 90 °C / 10 – 90% r.H.	< 0.5	V/A	●	●	●	●	●			●		Ethernet	3.1

T<sub>A</sub>: ambient above temperature

V: Visual

A: Acoustic

● Available

( ) Speed Control Fan

\* Option

1 MK 53: RS422

# Our general standard requirements for the operation of BINDER units

► GENERAL STANDARDS

Name	Description
DIN EN ISO 9001:2008-12	Quality management systems – Requirements (ISO 9001:2008); Trilingual version EN ISO 9001:2008
BINDER factory standard: 2013-11	Factory standard for determining the technical data of BINDER products
DIN 12880:2007-05	Electrical laboratory devices – Heating ovens and incubators
ASTM E 145-94:1994	Standard Specification for Gravity-Convection and Forced-Ventilation Ovens
ASTM D 5374-13	Standard Test Methods for Forced-Convection Laboratory Ovens for Evaluation of Electrical Insulation
DIN EN 1539:2012-04	Dryers and ovens, in which flammable substances are released – Safety requirements; German version prEN 1539:2012
ATEX equipment directive 94/9/EC	Directive 94/9/EC on equipment and protective systems intended for use in potentially explosive atmospheres
DIN EN 60216-4-1:2006-12	Electrical insulating materials – Thermal endurance properties – Part 4-1: Ageing ovens – Single-chamber ovens (IEC 60216-4-1:2006); German version EN 60216-4-1:2006
Directive 2003/94/EC	Principles and guidelines of good manufacturing practice in respect of medicinal products for human use and investigational medicinal
ICH Q1A (R2)	Stability Testing of new Drug Substances and Products
21 CFR 210 and 21 CFR 211	Current Good Manufacturing Practice (cGMP)

► EXCERPT FROM INDUSTRY STANDARDS CONCERNING ENVIRONMENTAL SIMULATION CHAMBERS

Name	Description	Unit
DIN EN 60068-2-1:2008-01	Environmental testing – Part 2-1: Tests – Test A: Cold (IEC 60068-2-1:2007); German version EN 60068-2-1:2007	MKFT
DIN EN 60068-2-2:2008-05	Environmental testing – Part 2-2: Tests - Test B: Dry heat (IEC 60068-2-2:2007); German version EN 60068-2-5: 2007	MKT   MKFT
DIN EN 60068-2-14:2010-09	Environmental testing – Part 2-14: Tests - Test N: Environmental testing – Tests – Test N. Change of temperature; (IEC 60068-2-14:2009); German version EN 60068-2-14:2009	MK   MKFT
DIN EN 60068-2-30:2006-06	Environmental testing – Part 2-30: Tests – Test Db: Damp heat, cyclic (12 h + 12 h cycle) (IEC 60068-2-30:2005); German version EN 60068-2-30:2005	MKF   MKFT
DIN EN 60068-2-38:2010-06	Environmental testing – Part 2-38: Tests – Test Z/AD: Composite temperature/humidity cyclic test (IEC 60068-2-38:2009); German version EN 60068-2-38:2009	MKF   MKFT
DIN EN 60068-2-66:1995-06	Environmental testing – Part 2: Test methods – Test Cx: Damp heat, steady state (unsaturated pressurized vapour) (IEC 60068-2-66:1994); German version EN 60068-2-66:1994	MKF   MKFT
DIN EN 60068-2-78:2010-10	Environmental testing – Part 2-78: Tests – Test Cab: Damp heat, steady state (IEC 104/523/CD:2010)	MKF   MKFT
DIN EN 60068-3-5:2002-12	Environmental testing – Part 3-5: Supporting documentation and guidance; Confirmation of the performance of temperature chambers (IEC 60068-3-5:2001); German version EN 60068-3-5:2002	MKT   MKF   MKFT
DIN EN 61215:2006-02, 10.11	Crystalline silicon terrestrial photovoltaic (PV) modules – Design qualification and type approval (IEC 61215:2005); German version EN 61215:2005	MKT   MKF   MKFT
DIN EN 61215:2006-02, 10.12	Crystalline silicon terrestrial photovoltaic (PV) modules – Design qualification and type approval (IEC 61215:2005); German version EN 61215:2005	MKF   MKFT
DIN EN 61215:2006-02, 10.13	Crystalline silicon terrestrial photovoltaic (PV) modules – Design qualification and type approval (IEC 61215:2005); German version EN 61215:2005	MKF   MKFT
DIN EN 61646:2009-03, 10.11	Thin-film terrestrial photovoltaic (PV) modules – Design qualification and type approval (IEC 61646:2008); German version EN 61646:2008	MKT   MKF   MKFT
DIN EN 61646:2009-03, 10.12	Thin-film terrestrial photovoltaic (PV) modules – Design qualification and type approval (IEC 61646:2008); German version EN 61646:2008	MKF   MKFT
DIN EN 61646:2009-03, 10.13	Thin-film terrestrial photovoltaic (PV) modules – Design qualification and type approval (IEC 61646:2008); German version EN 61646:2008	MKF   MKFT
MIL STD 331:2005-01	Fuze and Fuze Components, Environmental and Performance Tests	MKFT
MIL STD 810:2000-01	Environmental Engineering Considerations and Laboratory Tests	MKF   MKFT
BMW PR 303	Climatic testing of plastic and textile components in the vehicle interior and for instrumentation	MKFT
BMW PR 308	Climatic testing of adhesive joints for instrumentation	MKFT
Porsche PPV 4017	Corrosion testing – Modified climate change test	MKFT
Porsche PTL 8140	Requirements on interior components	MKFT

For details see products



# BINDER – The Mission

## | Technology for a better world

BINDER's core purpose is to make a significant technical contribution to improving the health and safety of mankind. Our aim is to provide our customers with products that best support their daily laboratory work and allow them to continuously improve results.

We strive unremittingly for perfection and to differentiate ourselves from others through continuous innovation. To this end, the percentage of our revenues that we invest in research and development annually is well above the industry average.

Consequently, our customers are at the center of all our reflections and activities.

They not only work with our products, they also inspire and drive us to improve every day.

Everyone at BINDER is dedicated to meeting our customers' requirement beyond their expectations.

To ensure the highest quality standards, all our products are solely manufactured at our state-of-the-art plant in Germany. Our exclusive focus on simulation chambers makes us the world's largest specialist in the market. We intend to maintain our step ahead and in that regard, we will work with the same responsibility, passion and desire as we have since the foundation of BINDER.

Peter Michael Binder

President & CEO





## BINDER – The company

### | Best conditions for your success

BINDER is a family business dedicated to simulation chambers. We are the world's largest specialist in simulation chambers for the scientific and industrial laboratory.

More than 23,000 units leave our plant in Tuttlingen annually.

Proven cutting-edge technologies, pioneering innovations and absolute precision characterize the BINDER brand image. Our focus lies in the perfect simulation of biological, chemical and physical environmental conditions for a number of industries. Our logo's three red triangles stand for: superior products, best service package and professional consultation. Our tagline embodies these values by providing: *"best conditions for your success"*.

In addition to our range of products, we offer our customers a comprehensive selection of options and accessories, making it possible to optimize standard units to your requirements profile. BINDER INDIVIDUAL offers flexible solutions adapted to the customer's particular requirements.

Whatever requirements may be, we can support and guide you locally from our headquarters in Tuttlingen and from our four BINDER offices in New York, Moscow, Hong Kong and Shanghai, as well as through our sales partners in more than 135 countries.



## BINDER – Environmental responsibility

### | Good for you. Good for the environment.

For nearly three decades, we have been offering more to our customers: more innovation, safety and local support. This is also the case for the environment. We take into account ecology and sustainable environmental protection not only in the development and production of our chambers, but in everything we do as a company.

With this in mind, BINDER is committed to use material combinations that can be separated to enable recycling. This is why asbestos or mercury are not used in any BINDER chamber today or will ever be in the future. We consciously choose synthetic materials made of recycled resin in our manufacturing process without any compromise in quality.

- ▶ **Less energy consumption** – The geothermal heating system at the Research & Development Center has a transmission heat requirement of 40 % below that required by the German Energy Saving Ordinance (EnEV). Daylight harvesting system: large windows allow optimum use of daylight supported by daylight-dependent automatic blinds; green roof for heat insulation; energy savings by the use of state-of-the-art equipment and systems and adaptive lighting systems. We are dedicated to reducing energy consumption which is why a combined heating and power station is in planning.
- ▶ **Stringent selection of suppliers in accordance with the European Ecodesign Directive** – Reusable packaging with upstream suppliers is used whenever possible. Materials such as steel, plastics, cardboard and paper are consistently recycled. Renewable and recycled materials are given preference wherever possible.
- ▶ **Less environmental impact** – The extensive oil-free steel processing performed with automatic machines allows BINDER to dispense with cleaning procedures detrimental to the environment before surface coating. Only solvent-free powder coating systems are used at BINDER.
- ▶ **Less resource consumption** – Use of up to 100 % recyclable packaging; 98 % powder reprocessing thanks to closed circuit coating system; 70 % less paper consumption thanks to digital workflow.



# Drying and tempering

## | Always the right temperature

Test chambers used in laboratories, must achieve temperature stress testing requirements far beyond temperature accuracy, heat distribution and residue-free drying. This is the case with a chamber used to dry flammable materials that must meet safety standards.

BINDER masters these requirements like no other and offers you a wide range of drying and heating ovens, as well as material test chambers. Choose from ovens with gravity (natural) or mechanical (forced) convection for safety or vacuum drying. BINDER INDIVIDUAL meets your special requirements for these products as well.





# Drying and heating ovens

## ED | FD | FED series

### Unsurpassed efficiency: BINDER Drying and Heating ovens

- ▶ Unsurpassed precision
  - ▶ Wide temperature range of 5 °C above ambient temperature to 300 °C
  - ▶ Fast, uniform tempering
  - ▶ Identical test conditions throughout the chamber interior
  - ▶ High standard according to DIN 12880 (27-point measurement)
- ▶ Unsurpassed reliability
  - ▶ Durable construction based on corrosion-resistant materials
  - ▶ Large capacity reserves
  - ▶ Short heating up and recovery times
  - ▶ Material temperature protection through an independent temperature safety device Class 2
- ▶ Unsurpassed versatility
  - ▶ Available with gravity (natural) and mechanical (forced) convection
  - ▶ Digital multifunctional controller with advanced timer functions
  - ▶ Communication interface
  - ▶ Adjustable front ventilation flap slide

Whether by gravity (natural) or mechanical (forced) convection, our drying and heating ovens provide high standards of quality and process stability. The wide temperature range of 5 °C above ambient temperature to 300 °C allows short heating up times and provide large capacity reserves. The excellent thermal insulation also reduces operating costs.



Paint industry

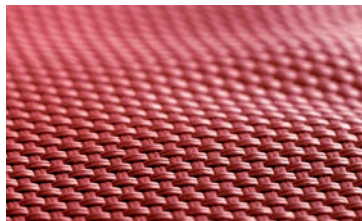

Textile industry



Precision engineering



# Drying ovens with gravity convection

## ED series

Routine drying and sterilization applications up to 300 °C and precision heat storage are the strength of ED drying ovens. Drying processes run more efficiently with gravity (natural) convection and the high rate of air exchange.



► ED 53 model



Available sizes (liters)

### ► EQUIPMENT

- Temperature range from 5 °C above ambient temperature to 300 °C
- DS control with integrated timer 0 to 99 hrs
- Digital temperature setting with an accuracy of one degree
- Independent adjustable temperature safety device class 2 (DIN 12880), with visual temperature alarm
- Adjustable ventilation by means of front ventilation flap slide and rear exhaust Ø 50 mm
- Optional RS 422 Interface for APT-COM™ Data Control System communication software
- Units up to 115 liters are stackable
- Two chrome-plated racks included



► **ED SERIES | BEST DRYING RESULTS:**



**Uniform drying conditions**

- APT.line™ preheating chamber
  - Homogeneous temperature control with gravity (natural) convection
  - Identical test conditions throughout the chamber interior independent of sample size and quantity

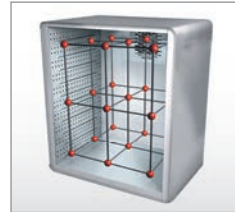

**Best quality and precision guaranteed**

- High standard according to DIN 12880 (27-point measurement)
- Short delivery times
- Minimal maintenance and operating costs

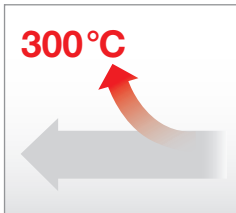

**Broad range of applications**

- Standard temperature range up to 300 °C
- Large capacity reserves
- Short heating up times

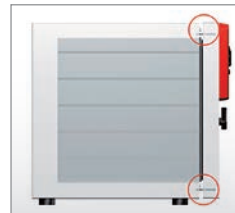

**Convenient work environment**

- Hermetic door closure with 2-points door closure
- Low heat dissipation due to 60 mm insulation
- Rack with tilt protection for easy loading and unloading
- Complete stainless steel inner chamber without permanent fixtures
- Easy cleaning

► **OPTIONS**

- Access ports of various diameters with silicone plugs
- Racks, chrome-plated or stainless steel
- Perforated shelf, stainless steel
- Independent temperature safety device class 3.1 according to DIN 12880
- Door with window and interior lighting
- Door lock
- Door gasket made of FKM (Viton)
- Switchable audio alarm for overheating
- Analog output for temperature 4 – 20 mA with 6-pin DIN socket
- Temperature measurement according to DIN 12880
- Calibration certificate
- Extension to factory calibration certificate (additional measuring point)
- Data Logger Kits and Logger Software



Access ports with silicone plugs

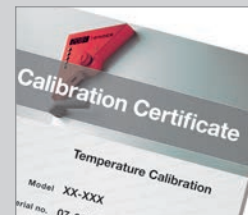

Calibrations and validations



Door with window and interior lighting



Drying oven with special door access port for loading test materials

► **BINDER INDIVIDUAL**  
More information from page 90

# Technical data for your planning and installation

## ED series



	ED 23	ED 53	ED 115	ED 240	ED 400	ED 720
<b>Exterior dimensions</b>						
Width (mm)	435	635	835	1035	1235	1235
Height (inclusive feet/casters) (mm)	495	620	705	825	1025	1530
Depth (mm)	520	575	645	745	765	865
Plus door handle, I-panel and exhaust duct (mm)	105	105	105	105	105	105
Quantity of doors	1	1	1	2	2	2
<b>Interior dimensions</b>						
Width (mm)	225	400	600	800	1000	1000
Height (mm)	330	400	480	600	800	1200
Depth (mm)	300	350	420	520	520	620
Interior volume (l)	20	53	115	240	400	720
Quantity of racks (standard/max.)	2 / 3	2 / 5	2 / 6	2 / 7	2 / 10	2 / 15
Load per rack (kg)	12	15	20	30	35	45
Permitted total load (kg)	25	40	50	70	90	120
Weight of the unit (empty) (kg)	22	42	57	86	125	174
<b>Temperature data</b>						
Temperature range, 5 °C above ambient up to (°C)	300	300	300	300	300	300
Temperature uniformity at 150 °C (± K) <sup>1)</sup>	2.5	3.2	2.5	2.5	3.0	2.8
Temperature fluctuation at 150 °C (± K) <sup>1) 2)</sup>	0.3	0.3	0.3	0.3	0.3	0.3
Heating-up time to 150 °C (min) <sup>1) 2)</sup>	24	27	29	48	62	69
Recovery time after door was opened for 30 sec. at 150 °C (min) <sup>1) 2)</sup>	5	6	9	13	20	14
Air change at 150 °C (x/h)	13	19	10	10	10	9
<b>Electrical data</b>						
Housing protection acc. to EN 60529	IP 20	IP 20	IP 20	IP 20	IP 20	IP 20
Nominal voltage (±10%) 50/60 Hz (V)	230 1 N ~	230 1 N ~	230 1 N ~	230 1 N ~	400 3 N ~	400 3 N ~
Nominal power (kW)	0.8	1.2	1.6	2.7	3.4	5.0
Energy consumption at 150 °C (W)	148	210	300	447	672	750
<b>Model no. without RS 422</b>						
	9010-0190	9010-0078	9010-0096	-	-	-
<b>Model no. with RS 422</b>						
	9010-0191	9010-0079	9010-0097	9010-0101	9010-0075	9010-0076

<sup>1)</sup> value without window // <sup>2)</sup> to 98 % of the set value /// All technical data are specified for units with standard equipment at an ambient temperature of 25 °C and a voltage fluctuation of ±10 %.

The temperature data are determined in accordance with factory standard following DIN 12880 respecting the recommended wall clearances of 10 % of the height, width and depth of the inner chamber.

All indications are average values, typical for units produced in series. We reserve the right to change technical specifications at any time.



► DIMENSIONS

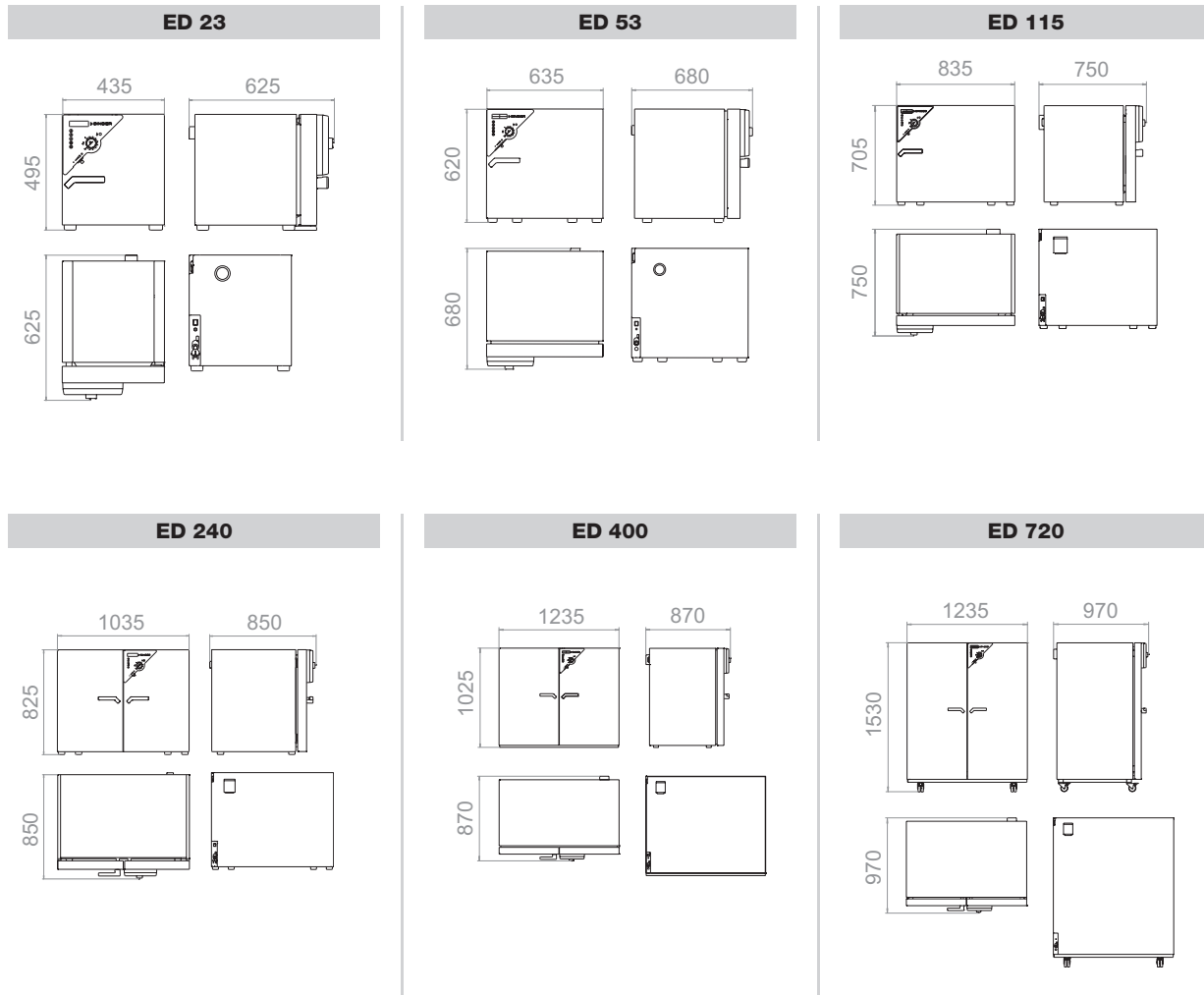

► INSTALLATION REQUIREMENTS

	ED 23	ED 53	ED 115	ED 240	ED 400	ED 720
Wall clearance rear (mm)	100	100	100	100	100	100
Wall clearance side (mm)	100	160	160	160	160	160
Nominal voltage ( $\pm 10\%$ ) 50/60 Hz (V)	230 1 N ~	230 1 N ~	230 1 N ~	230 1 N ~	400 3 N ~	400 3 N ~
Nominal power (kW)	0.8	1.2	1.6	2.7	3.4	5

# Drying ovens with mechanical convection

## FD series

The FD series is the optimal choice when fast drying and sterilization are required. With fully homogeneous temperature distribution, quick dynamics and powerful fan, the FD saves valuable time.

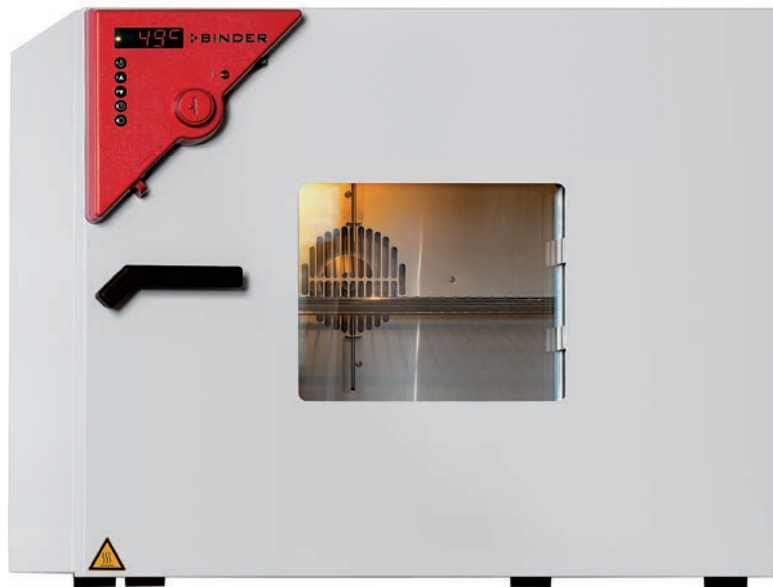

► FD 115 model  
with option window



### ► EQUIPMENT

- Temperature range from 5 °C above ambient temperature to 300 °C
- DS control with integrated timer 0 to 99 hrs
- Digital temperature setting with an accuracy of one degree
- Independent adjustable temperature safety device class 2 (DIN 12880), with visual temperature alarm
- Adjustable ventilation by means of front ventilation flap slide and rear exhaust Ø 50 mm
- Units up to 115 liters are stackable
- Two chrome-plated racks included

► **FD SERIES | BEST DRYING RESULTS:**

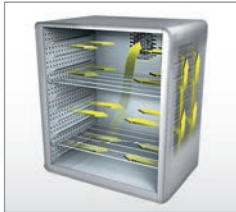

**Uniform drying conditions**

- APT.line™ preheating chamber
- Homogeneous temperature control with mechanical (forced) convection
- Identical test conditions throughout the chamber interior independent of sample size and quantity

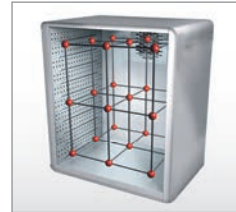

**Best quality and precision guaranteed**

- High standard according to DIN 12880 (27-point measurement)
- Short delivery times
- Minimal maintenance and operating costs

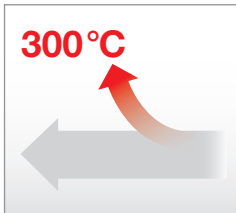

**Broad range of applications**

- Standard temperature range up to 300 °C
- Large capacity reserves
- Short heating up times



**Convenient work environment**

- User-friendly microprocessor control
- Hermetic door closure with 2-points door closure
- Low heat dissipation due to 60 mm insulation
- Rack with tilt protection for easy loading and unloading
- Complete stainless steel inner chamber without permanent fixtures
- Easy cleaning

► **OPTIONS**

- Access ports of various diameters with silicone plugs
- Racks, chrome-plated or stainless steel
- Perforated shelf, stainless steel
- Independent temperature safety device class 3.1 according to DIN 12880
- Door with window and interior lighting
- Door lock
- Door gasket made of FKM (Viton)
- Switchable audio alarm for overheating
- Analog output for temperature 4 – 20 mA with 6-pin DIN socket
- Temperature measurement according to DIN 12880
- Calibration certificate
- Extension to factory calibration certificate (additional measuring point)
- Data Logger Kits and Logger Software



Access ports with silicone plugs



Reinforced shelves



Door with window and interior lighting



Drying oven with partitioned inner chamber and suspensions

► **BINDER  
INDIVIDUAL**  
More information  
from page 90

# Technical data for your planning and installation

## FD series



	FD 23	FD 53	FD 115	FD 240
<b>Exterior dimensions</b>				
Width (mm)	435	635	835	1035
Height (inclusive feet) (mm)	495	620	705	825
Depth (mm)	520	575	645	745
Plus door handle, I-panel and exhaust duct (mm)	105	105	105	105
Quantity of doors	1	1	1	2
<b>Interior dimensions</b>				
Width (mm)	225	400	600	800
Height (mm)	330	400	480	600
Depth (mm)	300	340	410	510
Interior volume (l)	20	53	115	240
Quantity of racks (standard/max.)	2 / 3	2 / 5	2 / 6	2 / 7
Load per rack (kg)	12	15	20	30
Permitted total load (kg)	25	40	50	70
Weight of the unit (empty) (kg)	33	44	62	96
<b>Temperature data</b>				
Temperature range, 5 °C above ambient up to (°C)	300	300	300	300
Temperature uniformity at 150 °C (± K) <sup>1)</sup>	2.2	2.0	1.8	2.0
Temperature fluctuation at 150 °C (± K) <sup>1) 2)</sup>	0.3	0.3	0.3	0.3
Heating-up time to 150 °C (min.) <sup>1) 2)</sup>	22	24	28	24
Recovery time after door was opened for 30 sec. at 150 °C (min.) <sup>1) 2)</sup>	4	5	5	6
Air change at 150 °C (x/h)	64	64	32	20
<b>Electrical data</b>				
Housing protection acc. to EN 60529	IP 20	IP 20	IP 20	IP 20
Nominal voltage (±10%) 50/60 Hz (V)	230 1 N ~	230 1 N ~	230 1 N ~	230 1 N ~
Nominal power (kW)	0.8	1.2	1.6	2.7
Energy consumption at 150 °C (W)	300	429	544	850
<b>Model no.</b>				
	9010-0194	9010-0082	9010-0102	9010-0104

<sup>1)</sup> value without window // <sup>2)</sup> to 98 % of the set value /// All technical data are specified for units with standard equipment at an ambient temperature of 25 °C and a voltage fluctuation of ±10 %.

The temperature data are determined in accordance with factory standard following DIN 12880 respecting the recommended wall clearances of 10 % of the height, width and depth of the inner chamber.

All indications are average values, typical for units produced in series. We reserve the right to change technical specifications at any time.



► DIMENSIONS

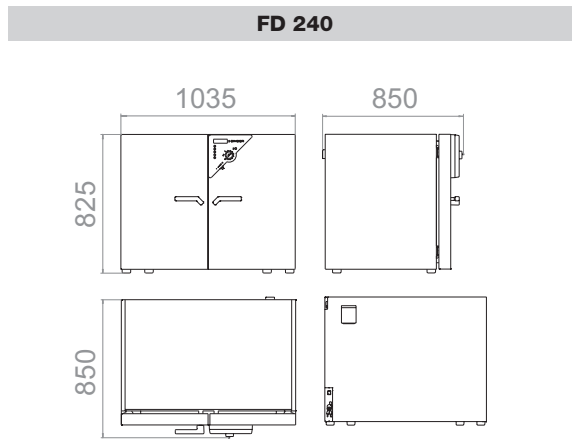
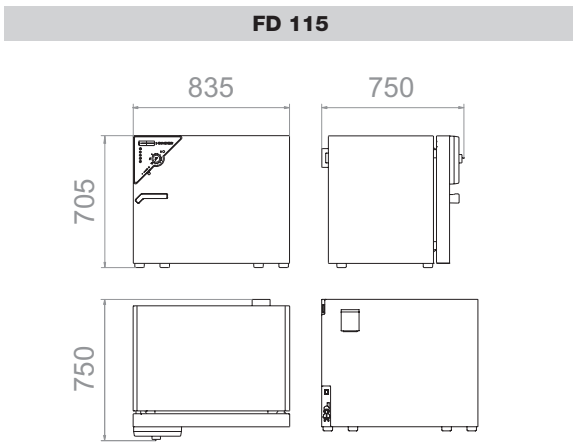
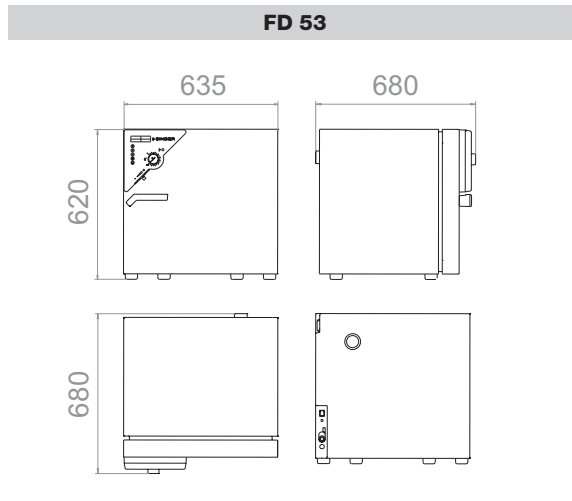
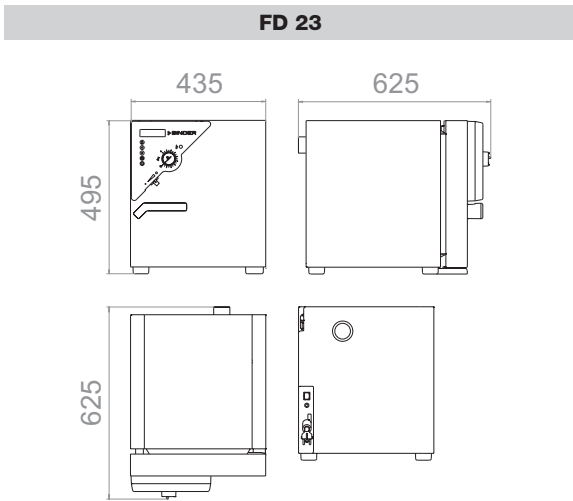

► INSTALLATION REQUIREMENTS

	FD 23	FD 53	FD 115	FD 240
Wall clearance rear (mm)	100	100	100	100
Wall clearance side (mm)	100	160	160	160
Nominal voltage ( $\pm 10\%$ ) 50/60 Hz (V)	230 1 N ~	230 1 N ~	230 1 N ~	230 1 N ~
Nominal power (kW)	0.8	1.2	1.6	2.7



# Heating chambers with mechanical convection FED series

Our multi-talented series: almost unlimited capacity and particularly adaptable to the individual requirements of many different tests. With advanced timing functions and a digitally controllable fan, temperature and convection conditions are easily controlled.



► FED 240 model

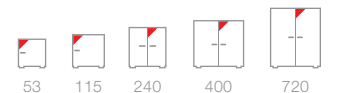

Available sizes (liters)

## ► EQUIPMENT

- Temperature range from 5 °C above ambient temperature to 300 °C
- MS controller with several timer functions
- Controller timer functions: delayed ON, delayed OFF, temperature dependent delayed OFF
- Digital temperature setting with an accuracy of one degree
- Adjustable fan speed
- Adjustable ventilation by means of front ventilation flap slide and rear exhaust Ø 50 mm
- Independent adjustable temperature safety device class 2 (DIN 12880), with visual temperature alarm
- RS 422 interface for APT-COM™ DataControlSystem communication software
- Units up to 115 liters are stackable
- Two chrome-plated racks included

► **FED SERIES | BEST DRYING RESULTS:**

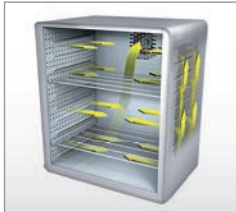

**Uniform drying conditions**

- APT.line™ preheating chamber
  - Homogeneous temperature control with mechanical (forced) convection
  - Identical test conditions throughout the chamber interior independent of sample size and quantity

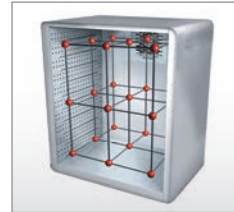

**Best quality and precision guaranteed**

- High standard according to DIN 12880 (27-point measurement)
- Short delivery times
- Minimal maintenance and operating costs



**User-friendly controller**

- Digital multifunctional controller (MS)
  - Advanced timing functions
  - In the user's field of vision
  - Easy to operate



**Convenient work environment**

- User-friendly microprocessor control
- Hermetic door closure with 2-points door closure
- Low heat dissipation due to 60 mm insulation
- Rack with tilt protection for easy loading and unloading
- Complete stainless steel inner chamber without permanent fixtures
- Easy cleaning

► **OPTIONS**

- Access ports of various diameters with silicone plugs
- Racks, chrome-plated or stainless steel
- Perforated shelf, stainless steel
- Independent temperature safety device class 3.1 according to DIN 12880
- Door with window and interior lighting
- Door lock
- Door gasket made of FKM (Viton)
- Switchable audio alarm for overheating
- Analog output for temperature 4 – 20 mA with 6-pin DIN socket
- Temperature measurement according to DIN 12880
- Calibration certificate
- Extension to factory calibration certificate (additional measuring point)
- Data Logger Kits and Logger Software



Data Logger Kits



Reinforced shelves



Door with window and interior lighting



Heating chamber with special extension for loading without opening the door

► **BINDER  
INDIVIDUAL**  
More information  
from page 90

1

2

3

4

5

# Technical data for your planning and installation

## FED series



	FED 53	FED 115	FED 240	FED 400	FED 720
<b>Exterior dimensions</b>					
Width (mm)	635	835	1035	1235	1235
Height (inclusive feet/casters) (mm)	620	705	825	1025	1530
Depth (mm)	575	645	745	765	865
Plus door handle, I-panel and exhaust duct (mm)	105	105	105	105	105
Quantity of doors	1	1	2	2	2
<b>Interior dimensions</b>					
Width (mm)	400	600	800	1000	1000
Height (mm)	400	480	600	800	1200
Depth (mm)	340	410	510	510	610
Interior volume (l)	53	115	240	400	720
Quantity of racks (standard/max.)	2 / 5	2 / 6	2 / 7	2 / 10	2 / 15
Load per rack (kg)	15	20	30	35	45
Permitted total load (kg)	40	50	70	90	120
Weight of the unit (empty) (kg)	44	62	96	145	195
<b>Temperature data</b>					
Temperature range, 5 °C above ambient up to (°C)	300	300	300	300	300
Temperature uniformity at 150 °C (± K) <sup>1)</sup>	2.0	1.8	2.0	2.5	2.0
Temperature fluctuation at 150 °C (± K) <sup>1) 2)</sup>	0.3	0.3	0.3	0.3	0.3
Heating-up time to 150 °C (min.) <sup>1) 2)</sup>	24	30	27	35	39
Recovery time after door was opened for 30 sec. at 150 °C (min.) <sup>1) 2)</sup>	5	8	10	17	20
Air change at 150 °C (x/h)	43	32	20	18	12
<b>Electrical data</b>					
Housing protection acc. to EN 60529	IP 20	IP 20	IP 20	IP 20	IP 20
Nominal voltage (±10%) 50/60 Hz (V)	230 1 N ~	230 1 N ~	230 1 N ~	400 3 N ~	400 3 N ~
Nominal power (kW)	1.2	1.6	2.7	3.4	5.0
Energy consumption at 150 °C (W)	397	544	850	1200	1320
<b>Model no.</b>					
	9010-0210	9010-0212	9010-0214	9010-0216	9010-0218

<sup>1)</sup> value without window // <sup>2)</sup> to 98 % of the set value /// All technical data are specified for units with standard equipment at an ambient temperature of 25 °C and a voltage fluctuation of ±10 %.

The temperature data are determined in accordance with factory standard following DIN 12880 respecting the recommended wall clearances of 10 % of the height, width and depth of the inner chamber.

All indications are average values, typical for units produced in series. We reserve the right to change technical specifications at any time.

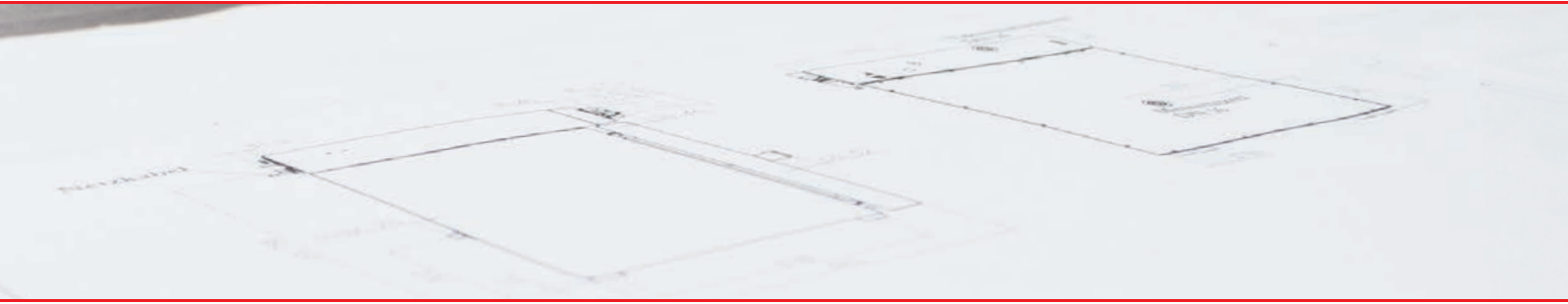

► DIMENSIONS

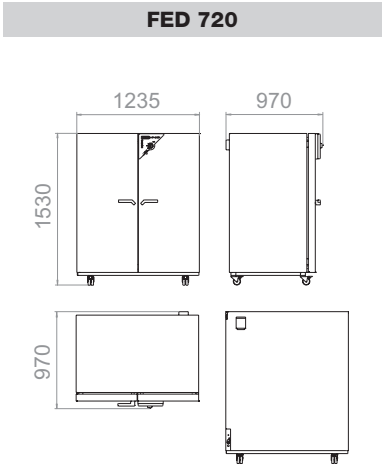
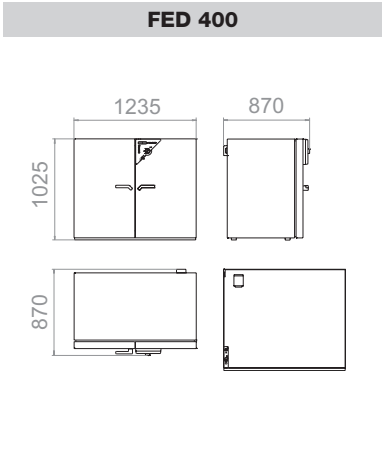
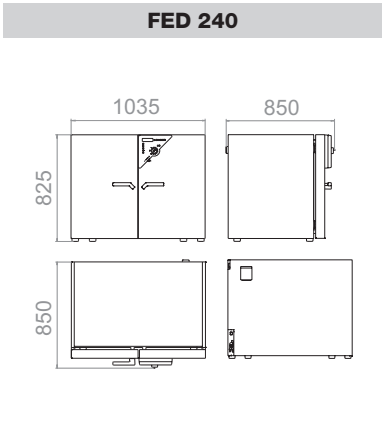
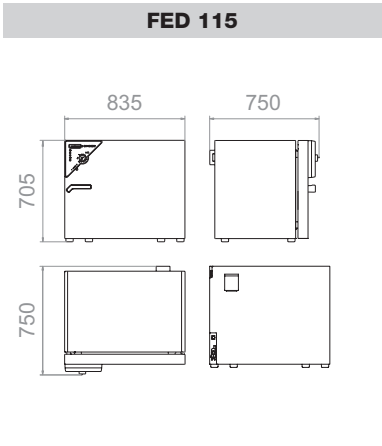
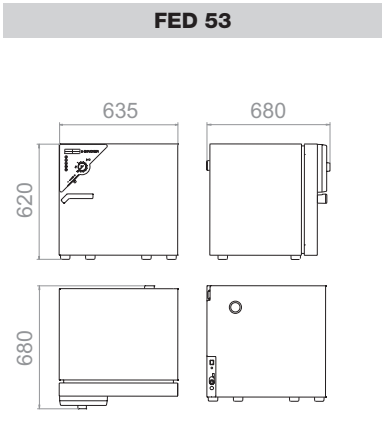

► INSTALLATION REQUIREMENTS

	FED 53	FED 115	FED 240	FED 400	FED 720
Wall clearance rear (mm)	100	100	100	100	100
Wall clearance side (mm)	160	160	160	160	160
Nominal voltage (±10 %) 50/60 Hz (V)	230 1 N ~	230 1 N ~	230 1 N ~	400 3 N ~	400 3 N ~
Nominal power (kW)	1.2	1.6	2.7	3.4	5.0

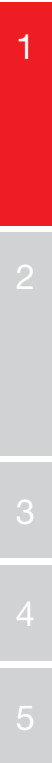



270°C

■ ■ ■ ■ ■

BINDER

# Material testing

## FP | M series

### Proven experts: BINDER Material test chambers

- ▶ Proven level of performance
  - ▶ Fan with increased airflow rate
  - ▶ Adjustable rapid air exchange rate
  
- ▶ Proven precision
  - ▶ High standard according to DIN 12880 (27-point measurement)
  - ▶ The specialists for demanding heating profiles
  - ▶ Uniform test conditions throughout the chamber interior
  
- ▶ Proven versatility
  - ▶ Communication interface
  - ▶ Digital multi-program controller
  - ▶ Adjustable ventilation, program-controlled (M series)

For demanding heating profiles, these chambers show what they're made of: Best APT.line™ preheating chamber for maximum precision, wide temperature range and comprehensive programming options, with which you can customize ramps, profiles and processes.



Seal manufacturers



Automation technology



Heat ageing

# Material test chambers with mechanical convection FP series

The FP series carries out the most demanding tests and scores particularly well with its comprehensive programming options. The mechanical (forced) convection provides reliably short drying and extremely fast heating times – even and especially for chambers under full loads.



► FP 115 model

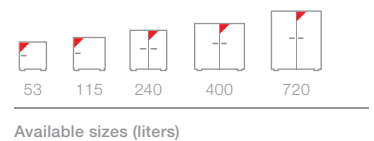

Available sizes (liters)

## ► EQUIPMENT

- Temperature range from 5 °C above ambient temperature to 300 °C
- MP controller with 2 programs with 10 sections each, alternatively switchable to program with 20 segments
- The time of an individual program step can be set to max. 999 hours and 59 minutes.
- Adjustable ramp function via program editor
- Integrated weekly program timer with real-time function
- Digital temperature setting accurate to tenths of a degree or to one degree
- Adjustable fan speed
- Adjustable ventilation by means of front ventilation flap slide and rear exhaust Ø 50 mm
- Elapsed time indicator
- Independent adjustable temperature safety device class 2 (DIN 12880), with visual temperature alarm
- RS 422 interface for APT-COM™ DataControlSystem communication software
- Units up to 115 liters are stackable
- Two chrome-plated racks included

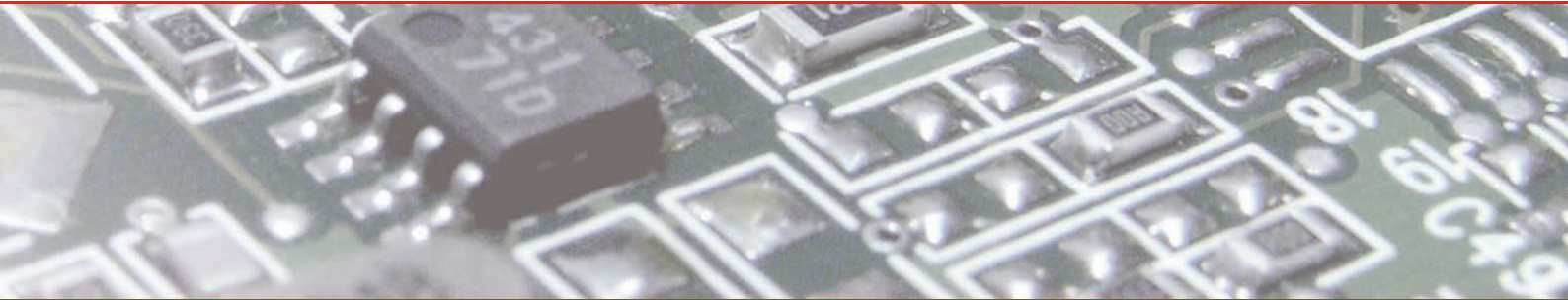

► FP SERIES | BEST TEST RESULTS:



**Uniform test conditions**

- ▶ APT.line™ preheating chamber
  - Homogeneous temperature distribution
  - Identical test conditions throughout the chamber interior independent of sample size and quantity



**Best quality and precision guaranteed**

- ▶ High standard according to DIN 12880 (27-point measurement)
- ▶ Short delivery times
- ▶ Minimal maintenance and operating costs

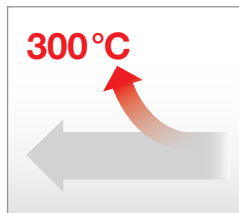

**Broad range of applications**

- ▶ Rapid air exchange rate and large capacity reserves
- ▶ Adjustable fan speed
- ▶ Short heating up times



**Convenient work environment**

- ▶ Hermetic door closure with 2-points door closure
- ▶ Low heat dissipation due to 60 mm insulation
- ▶ Rack with tilt protection for easy loading and unloading
- ▶ Complete stainless steel inner chamber
- ▶ No permanent fixtures

► OPTIONS

- Access ports with silicone plugs
- Racks, chrome-plated or stainless steel
- Perforated shelf, stainless steel
- Reinforced rack, stainless steel
- Reinforced inner chamber with 2 reinforced racks
- Independent temperature safety device class 3.1 according to DIN 12880
- Door with window and interior lighting
- Door lock
- Analog output for temperature 4 - 20 mA with 6-pin DIN socket including DIN connector
- Additional measuring channel for display of specimen temperature (PT 100 sensor)
- Temperature measurement according to DIN 12880
- HEPA fresh-air filter, class EU 14
- Increased air exchange rate through high-performance fan
- Measurement of air exchange rate according to ASTM D5374
- Isolated switching outputs (6-pin DIN socket)
- Calibration certificate
- Extension to calibration certificate
- Data Logger Kits and Logger software



Door with heated viewing window with interior lighting



Calibrations and validations

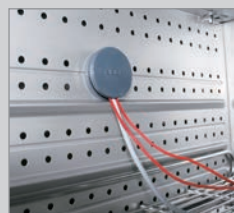

Access ports with silicone plugs



Test chamber with special racks and modified airflow

► **BINDER INDIVIDUAL**  
More information from page 90

1

2

3

4

5



# Technical data for your planning and installation

## FP series



	FP 53	FP 115	FP 240	FP 400	FP 720
<b>Exterior dimensions</b>					
Width (mm)	635	835	1035	1235	1235
Height (inclusive feet/casters) (mm)	620	705	825	1025	1530
Depth (mm)	575	645	745	765	865
Plus door handle, I-panel and exhaust duct (mm)	105	105	105	105	105
Quantity of doors	1	1	2	2	2
<b>Interior dimensions</b>					
Width (mm)	400	600	800	1000	1000
Height (mm)	400	480	600	800	1200
Depth (mm)	340	410	510	510	610
Interior volume (l)	53	115	240	400	720
Quantity of racks (standard/max.)	2 / 5	2 / 6	2 / 7	2 / 10	2 / 15
Load per rack (kg)	15	20	30	35	45
Permitted total load (kg)	40	50	70	90	120
Weight of the unit (empty) (kg)	45	62	98	145	185
<b>Temperature data</b>					
Temperature range, 5 °C above ambient up to (°C)	300	300	300	300	300
Temperature uniformity at 150 °C (± K) <sup>1)</sup>	2.0	1.8	2.0	2.5	2.0
Temperature fluctuation (± K) <sup>1),2)</sup>	0.3	0.3	0.3	0.3	0.3
Heating-up time to 150 °C (minutes) <sup>1),2)</sup>	24	30	27	35	39
Recovery time after door was opened for 30 sec. at 150 °C (min.) <sup>1),2)</sup>	5	8	10	17	20
Air change at 150 °C (x/h)	64	32	20	18	12
<b>Electrical data</b>					
Housing protection acc. to EN 60529	IP 20	IP 20	IP 20	IP 20	IP 20
Nominal voltage (± 10%) 50/60 Hz (V)	230 1 N ~	230 1 N ~	230 1 N ~	400 3 N ~	400 3 N ~
Nominal power (kW)	1.2	1.6	2.7	3.4	5.0
Energy consumption at 150 °C (W)	300	544	850	1200	1320
<b>Model no.</b>	<b>9010-0153</b>	<b>9010-0255</b>	<b>9010-0263</b>	<b>9010-0265</b>	<b>9010-0267</b>

<sup>1)</sup> value without window // <sup>2)</sup> to 98 % of the set value /// All technical data are specified for units with standard equipment at an ambient temperature of 25 °C and a voltage fluctuation of ±10 %. The temperature data are determined in accordance with factory standard following DIN 12880 respecting the recommended wall clearances of 10 % of the height, width and depth of the inner chamber. All indications are average values, typical for units produced in series. We reserve the right to change technical specifications at any time.

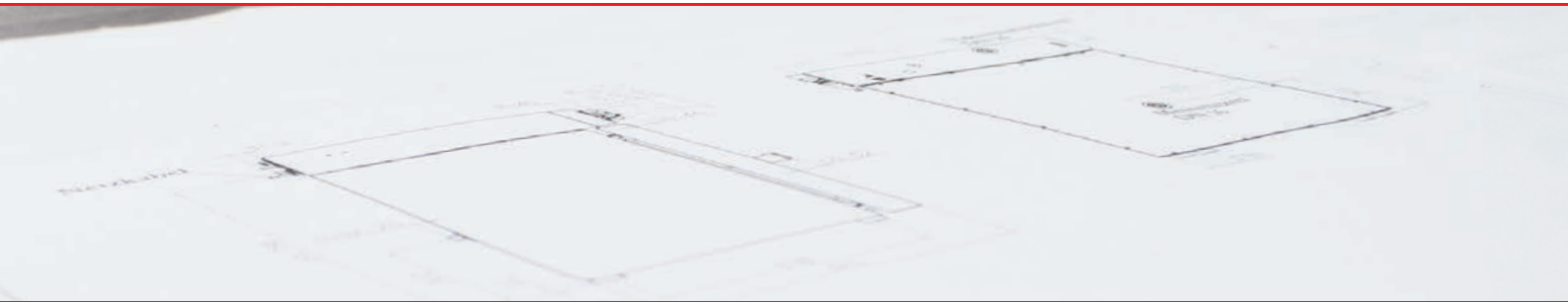

► DIMENSIONS

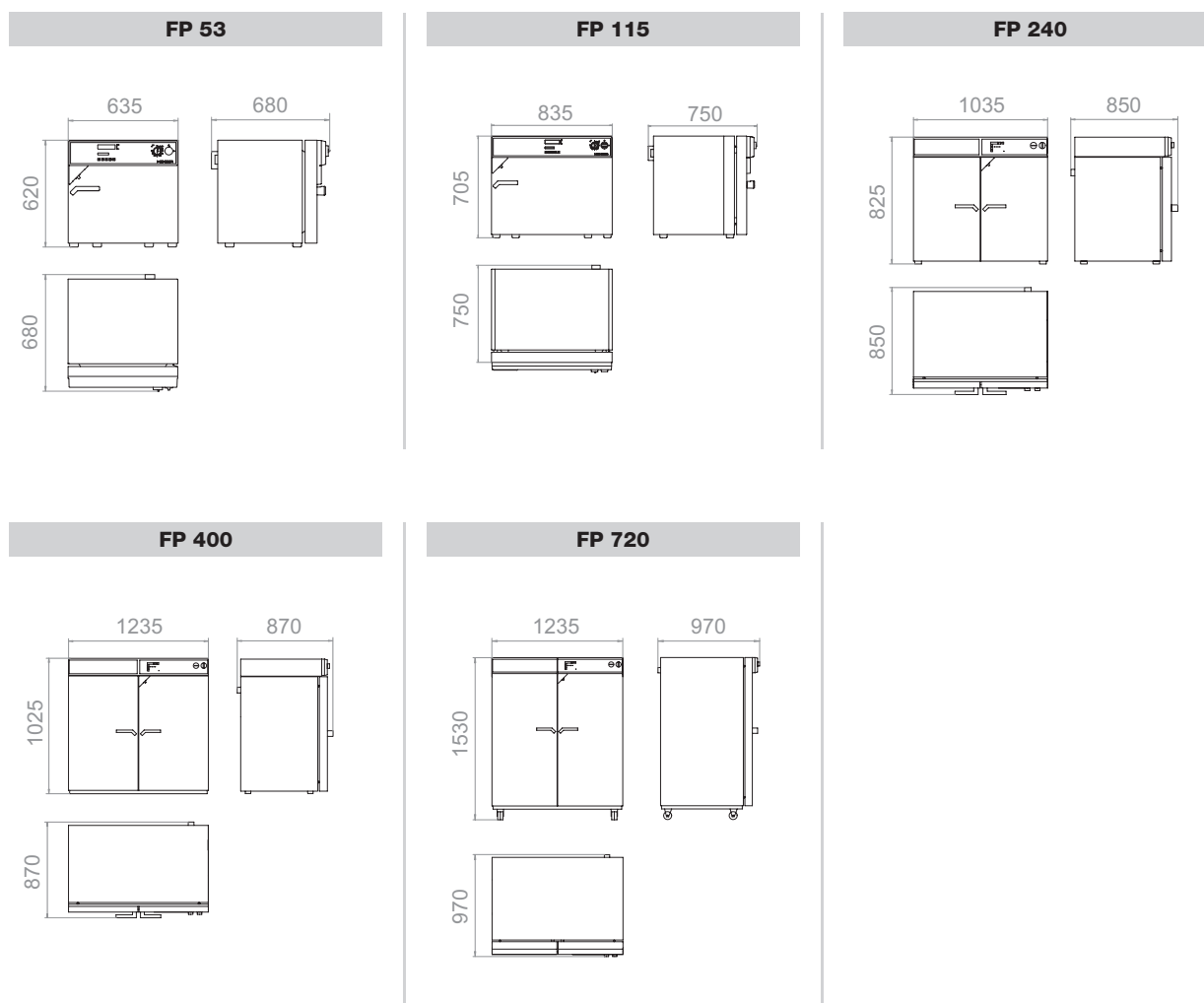

► INSTALLATION REQUIREMENTS

	FP 53	FP 115	FP 240	FP 400	FP 720
Wall clearance rear (mm)	100	100	100	100	100
Wall clearance side (mm)	160	160	160	160	160
Nominal voltage ( $\pm 10\%$ 50/60 Hz (V))	230 1N~	230 1N~	230 1N~	400 3N~	400 3N~
Nominal power (kW)	1.2	1.6	2.7	3.4	5.0



# Temperature test chambers with individual programming M series

With a maximum temperature of 300 °C and comprehensive programming options, the M series is ideally suited for material and accelerated aging testing. The particularly powerful airflow rate and programmable exhaust air valve ensure fast heating, and test temperatures are maintained at a level with minimal spatial fluctuations more accurately than ever before.



► M 720 model

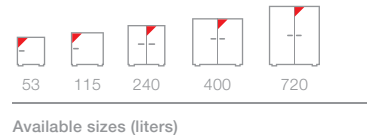

## ► EQUIPMENT

- Temperature range from 5 °C above ambient temperature to 300 °C
- MCS screen controller which can store 25 programs of 100 sections each for a maximum of 500 program segments:
  - User-friendly LCD screen
  - Easy-to-read menu guidance
  - Integrated electronic chart recorder
  - Variety of options for the graphic display of process parameters
  - Real-time clock
- Adjustable ramp function via program editor
- Program-controlled ventilation flap
- High air exchange rate through high-performance fan
- Adjustable fan speed
- Exhaust duct Ø 50 mm
- Independent adjustable temperature safety device class 2 (DIN 12880), with visual temperature alarm
- RS 422 interface for APT-COM™ DataControlSystem communication software
- Units up to 115 liters are stackable
- Two chrome-plated racks included

► M SERIES | BEST TEST RESULTS:



**Uniform test conditions**

- ▶ APT.line™ preheating chamber
  - Homogeneous temperature distribution
  - Same test conditions throughout the chamber interior independent of sample size and quantity



**Best quality and precision guaranteed**

- ▶ High standard according to DIN 12880 (27-point measurement)
- ▶ Short delivery times
- ▶ Minimal maintenance and operating costs

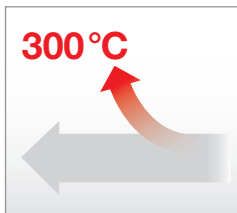

**Broad range of applications**

- ▶ High air exchange rate and large power reserves
- ▶ Adjustable fan speed
- ▶ Short heating up times



**Convenient work environment**

- ▶ Hermetic door closure with 2-points door closure
- ▶ Low heat dissipation due to 60 mm insulation
- ▶ Rack with tilt protection for easy loading and unloading
- ▶ Complete stainless steel inner chamber
- ▶ No permanent fixtures

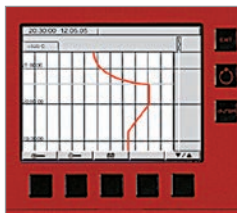

**Custom programming**

- ▶ Controller with color display which can store 25 programs
- ▶ Integrated digital continuous-line recorder for monitoring limits and alarm function
- ▶ Convenient documentation
- ▶ All displayed values read at a glance

► OPTIONS

- Access ports with silicone plugs
- Racks, chrome-plated or stainless steel
- Perforated shelf, stainless steel
- Reinforced rack, stainless steel
- Reinforced inner chamber with 2 reinforced racks
- Door with window and interior lighting
- Door lock
- Analog output for temperature 4 - 20 mA with 6-pin DIN socket
- Additional measuring channel for display of specimen temperature (PT 100 sensor)
- Inert gas connection (gas inlet and outlet)
- Temperature measurement according to DIN 12880
- HEPA fresh-air filter, class EU 14
- Ventilation measurement according to ASTM D5374 with definition and protocol
- Calibration certificate
- Extension to calibration certificate
- Data Logger Kits and Logger software



Reinforced shelves



Various access ports



Data Logger Kits

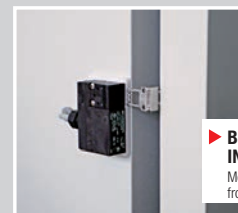

Test chamber with electrical door lock

► **BINDER INDIVIDUAL**  
More information from page 90

1

2

3

4

5

# Technical data for your planning and installation

## M series



	M 53	M 115	M 240	M 400	M 720
<b>Exterior dimensions</b>					
Width (mm)	635	835	1035	1235	1235
Height (inclusive feet/castors) (mm)	780	865	985	1185	1695
Depth (mm)	575	645	745	765	865
Plus door handle, I-panel and exhaust duct (mm)	105	105	105	105	105
Quantity of doors	1	1	2	2	2
<b>Interior dimensions</b>					
Width (mm)	400	600	800	1000	1000
Height (mm)	400	480	600	800	1200
Depth (mm)	340	410	510	510	610
Interior volume (l)	53	115	240	400	720
Quantity of racks (standard/max.)	2 / 5	2 / 6	2 / 7	2 / 10	2 / 15
Load per rack (kg)	15	20	30	35	45
Permitted total load (kg)	40	50	70	90	120
Weight of the unit (empty) (kg)	61	89	131	173	203
<b>Temperature data</b>					
Temperature range, 5 °C above ambient up to (°C)	300	300	300	300	300
Temperature uniformity at 150 °C (± K) <sup>1)</sup>	1.3	1.5	1.5	1.5	1.9
Temperature fluctuation (± K) <sup>1) 2)</sup>	0.3	0.3	0.3	0.3	0.3
Heating-up time to 150 °C (min.) <sup>1) 2)</sup>	15	16	19	18	21
Recovery time after door was opened for 30 sec. at 150 °C (min.) <sup>1) 2)</sup>	3	3	3	3	3
Air change at 150 °C (x/h)	192	96	60	54	36
<b>Electrical data</b>					
Housing protection acc. to EN 60529	IP 20	IP 20	IP 20	IP 20	IP 20
Nominal voltage (± 10%) 50/60 Hz (V)	230 1 N ~	230 1 N ~	230 1 N ~	400 3 N ~	400 3 N ~
Nominal power (kW)	1.2	1.6	2.7	3.4	5.0
Energy consumption at 150 °C (W)	300	544	850	1200	1320
Model no.	9010-0201	9010-0202	9010-0203	9010-0204	9010-0205

<sup>1)</sup> without glass door // <sup>2)</sup> to 98 % of the set value /// All technical data are specified for units with standard equipment at an ambient temperature of 25 °C and a voltage fluctuation of ±10 %.

The temperature data are determined in accordance with factory standard following DIN 12880 respecting the recommended wall clearances of 10 % of the height, width and depth of the inner chamber.

All indications are average values, typical for units produced in series. We reserve the right to change technical specifications at any time.

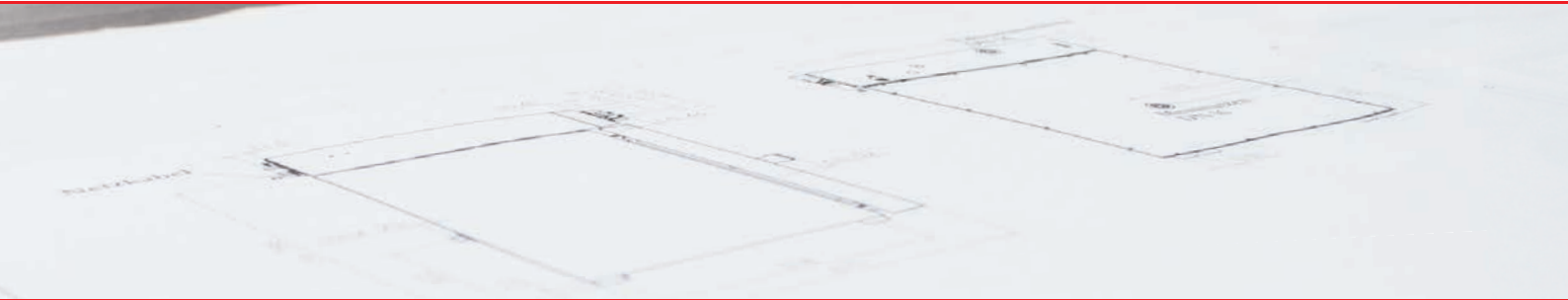

► DIMENSIONS

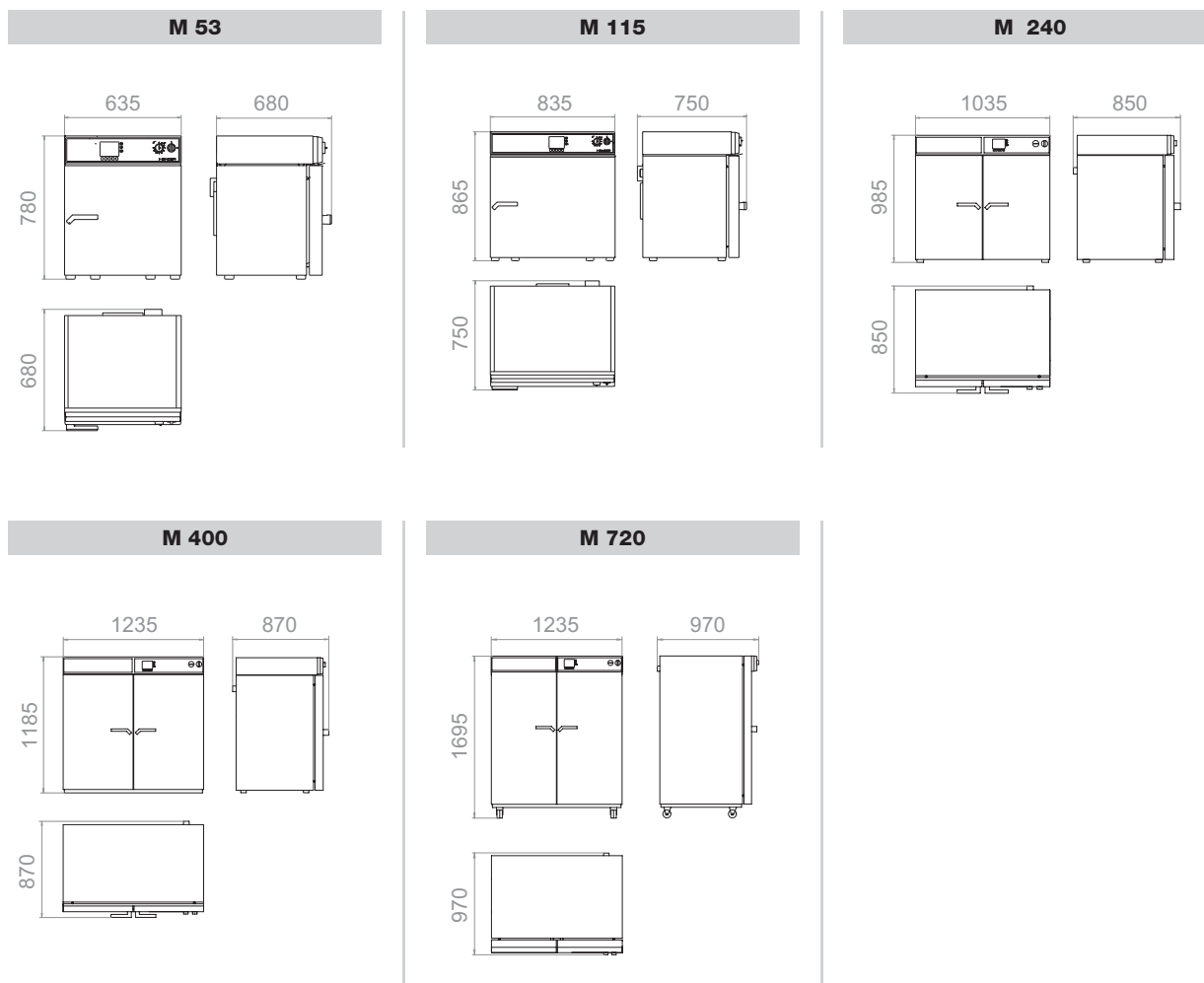

► INSTALLATION REQUIREMENTS

	FP 53	FP 115	FP 240	FP 400	FP 720
Wall clearance rear (mm)	100	100	100	100	100
Wall clearance side (mm)	160	160	160	160	160
Nominal voltage ( $\pm 10\%$ 50/60 Hz (V))	230 1N~	230 1N~	230 1N~	400 3N~	400 3N~
Nominal power (kW)	1.2	1.6	2.7	3.4	5.0

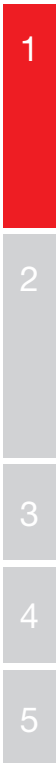



# Vacuum drying

## VD | VDL series

### Extremely superior: BINDER Vacuum drying ovens

- ▶ Extremely fast
  - ▶ Direct heat transfer to the sample material through thermal conducting plates
  - ▶ Fast, condensation-free drying processes
  - ▶ Homogeneous sample drying
  
- ▶ Extremely safe
  - ▶ VDL series with explosion-proof inner chamber (ATEX compliant: Zone EX II 3G)
  - ▶ Maximum specimen protection with adjusted overshooting
  - ▶ Ensures optimal work safety through its one-of-a-kind safety concept
  
- ▶ Extremely durable
  - ▶ Inner chamber made of highly corrosion resistant stainless steel V4A
  - ▶ Coordinated, modular system
  - ▶ Application-specific Vacuum chemical membrane pumps

Both VD and VDL ovens can dry samples completely without residues, scaling or oxidation, and this is achieved in overdrive. Depending on your individual safety requirements, our unique safety concept sets a new standard and is combined with a first-rate performance and quality.



Precision engineering



Plastics industry



Automation technology



# Vacuum drying ovens for non-flammable solvents

## VD series

The VD series makes a strong impression with its drying abilities which provide a homogeneous temperature distribution ensured by its electronically controlled APT.line™ preheating chamber. The patented shelf expansion technology guarantees optimal heat transfer. The shelves are easy to clean and provide a flexible positioning.



► VD 53 model



23 53 115

Available sizes (liters)

### ► EQUIPMENT

- Temperature range from 15 °C above ambient temperature to 200 °C
- MP controller with two programs with 10 sections each or switchable to one program with 20 sections
- Integrated weekly program timer with real-time function
- Digital temperature setting with an accuracy of one degree
- Precision-adjustable ventilation valve (for VD 23, the inert gas connection is also used as the ventilation valve)
- Precision-adjustable inert gas valve with Cross-Flow Technology
- All electrical components are decoupled from the inner chamber
- Spring-mounted safety glass panel with shatter protection
- Independent adjustable temperature safety device class 2 (DIN 12880), with visual temperature alarm
- Analog pressure gauge (displays pressure difference between the inner chamber and ambient pressure)
- Micro-polished inner chamber, suction and ventilation tubes, pressure container, expansion racks and ball valve are made of highly corrosion resistant stainless steel V4A
- Door gasket made of tempered silicone
- Two x 24 V DC (max 0.4 A) switching outputs, switched via two control contacts in the program editor
- RS 422 interface for APT-COM™ DataControlSystem communication software
- Two patented, flexible aluminum expansion racks
- Also available as complete system with module and vacuum pump

► **VD SERIES | FAST AND CONDENSATION-FREE DRYING PROCESS:**

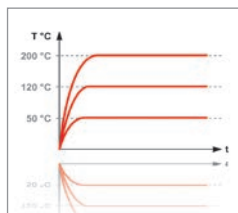

**Process stability for perfect results**

- Innovative control concept for regulation of the entire temperature range without overshooting
  - Short heating up times
  - Easy operation
- APT.line™ preheating chamber
  - Gentle drying throughout the chamber interior
  - Direct heat transfer through large thermal conducting plates
  - Patented, flexible positioning of the expansion racks

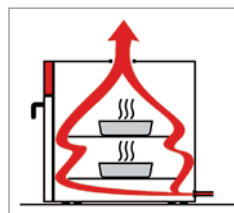

**Accelerated drying process**

- BINDER Cross-Flow Principle
- Even flow throughout the inner chamber from bottom to top
- Finely adjustable inert gas valve without turbulence for lighter samples
- Individually controlled



**Convenient, safe work environment**

- BINDER Complete system
- Coordinated, modular system consisting of vacuum drying oven, application-specific vacuum pumps and vacuum module (see page 48)
  - Connection kit for easy assembly
  - Optimal working height
  - Low noise
  - Pressure and temperature profiles are depicted simultaneously

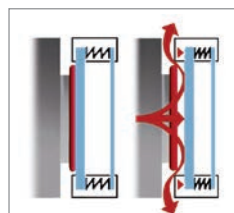

**Tested security**

- BINDER safety concept
- Spring-mounted safety glass panel with shatter protection
- Standard inert gas connection for interior flushing
- Electronic components are decoupled from the inner chamber



**Simple, time-saving cleaning**

- Smooth inner chamber with rounded corners
- Inner chamber and all connections made of highly corrosion resistant stainless steel V4A
  - Fixtures are fully removable

► **OPTIONS**

- Expansion racks, stainless steel
- Connection kit with various small-flange components
- Measuring port for vacuum-tight access port of measuring lines into the device (9-pin)
- Temperature measurement of the specimen with flexible PT 100 sensor and digital specimen temperature display
- Digital pressure display, measuring range from 1 mbar to atm. pressure, display accuracy 1 mbar
- Calibration certificates
- Extension to calibration certificate (additional measuring points)
- Door gasket, FKM (Viton)
- Vacuum module with chemical membrane pump VP 1.1
- Vacuum module with chemical membrane pump VP 2.1
- Vacuum module with speed-controlled chemical membrane pump VP 3.1
- Vacuum module for installation of vacuum pumps
- Measuring port
- Specimen temperature display with PT 100 sensor
- Validations and calibrations
- Vacuum drying oven with special racks for large numbers of particularly flat samples



Measuring port



Specimen temperature display with PT 100 sensor

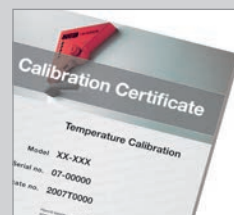

Validations and calibrations



Vacuum drying oven with special racks for large numbers of particularly flat samples

► **BINDER INDIVIDUAL**  
More information from page 90

# Technical data for your planning and installation

## VD series



	VD 23	VD 53	VD 115
<b>Exterior dimensions</b>			
Width (mm)	515	635	740
Height (inclusive feet) (mm)	655	775	900
Height VD + option "vacuum module" (mm)	1280	1400	1525
Depth (mm)	500	550	670
Plus door handle, connection (mm)	100	100	100
<b>Interior dimensions</b>			
Width (mm)	285	400	510
Height (mm)	285	400	510
Depth (mm)	295	340	460
Interior volume (l/cu.ft.)	23	53	115
Quantity of expansion racks (aluminum) (standard/max.)	2 / 4	2 / 5	2 / 6
Load per rack (kg/lbs.)	20	20	20
Permitted total load (kg/lbs.)	35	45	65
Weight of the unit (empty) (kg/lbs.)	63	95	153
<b>Temperature data</b>			
Temperature range, 15 °C above ambient up to (°C)	200	200	200
Temperature uniformity at 100 °C (± K) <sup>1)</sup>	1.5	2.0	3.5
Temperature fluctuation (± K) <sup>1)</sup>	0.1	0.1	0.1
Heating-up time to 100 °C (min.) <sup>1) 2)</sup>	65	80	95
Permitted end vacuum (mbar)	0.01	0.01	0.01
Leak rate max. (bar/h)	0.01	0.01	0.01
<b>Electrical data</b>			
Housing protection acc. to EN 60529	IP 20	IP 20	IP 20
Nominal voltage (±10%) 50/60 Hz (V)	230	230	230
Nominal power (kW)	0.8	1.2	1.9
Energy consumption at 100 °C (W)	105	150	250
<b>Model no.</b>			
	9030-0029	9030-0030	9030-0031

<sup>1)</sup> values measured with aluminum racks // <sup>2)</sup> to 98 % of the set value /// All technical data are specified for units with standard equipment at an ambient temperature of 25 °C and a voltage fluctuation of ±10 %. The temperature data are determined in accordance with factory standard following DIN 12880 respecting the recommended wall clearances of 10 % of the height, width and depth of the inner chamber. All indications are average values, typical for units produced in series. We reserve the right to change technical specifications at any time.

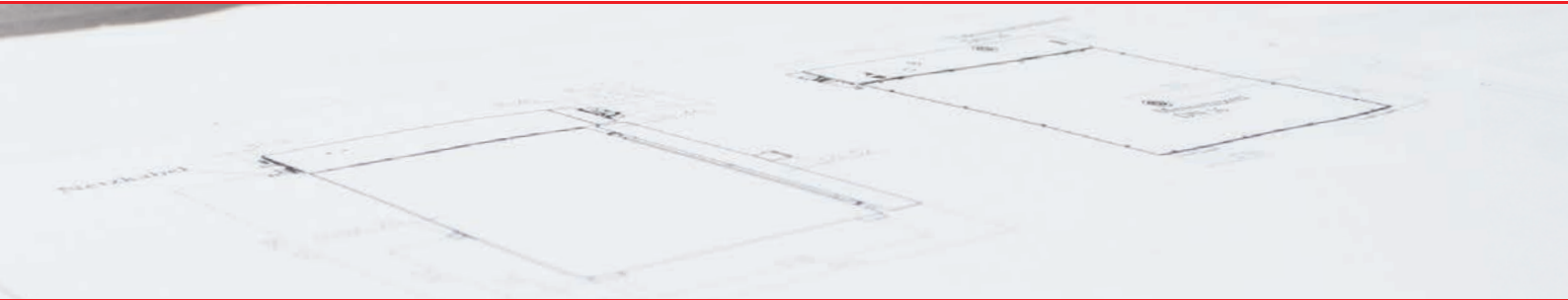

► DIMENSIONS

**VD 23**

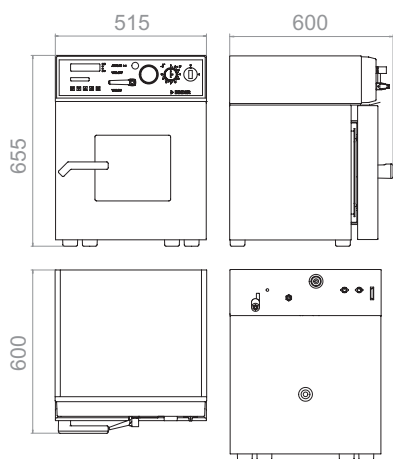

**VD 53**

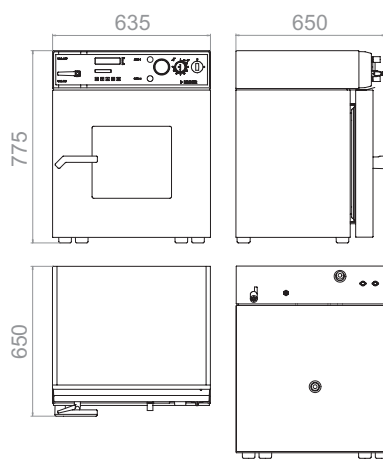

**VD 115**

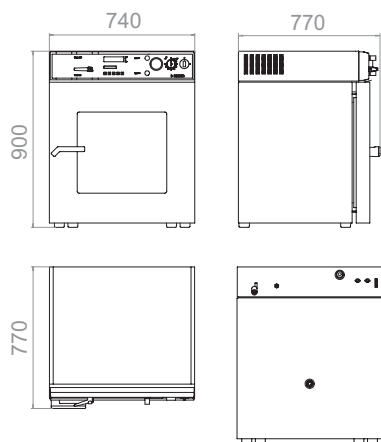

► INSTALLATION REQUIREMENTS

	VD 23	VD 53	VD 115
Nominal voltage ( $\pm 10\%$ ) 50/60 Hz (V)	230	230	230
Nominal power (kW)	0.8	1.2	1.9
Vacuum connection with small flange (DN mm/inch)	16 / 0.63	16 / 0.63	16 / 0.63
Measuring access port with small flange (DN mm/inch)	16 / 0.63	16 / 0.63	16 / 0.63
Inert gas connection with flow limiter (RP <sup>®</sup> )	3 / 8	3 / 8	3 / 8



# Safety vacuum drying ovens for flammable solvents

## VDL series

The safety package of the VDL series ensures maximum safety when drying organic solvents standard with TÜV/GS. The inner chamber is designed according to ATEX directive 94/9/EC for Zone EX II 3G.



► VDL 53 model



23 53 115

Available sizes (liters)

### ► EQUIPMENT

- Temperature range from 15 °C above ambient temperature to 200 °C
- MP controller with 2 programs with 10 sections each or switchable to one program with 20 segments
- Digital temperature setting with an accuracy of one degree
- Spring-mounted safety glass panel with shatter protection
- Pressure control device for heating activated < 125 mbar
- Over pressure capsuled instrument panel with compressed air connection and maintenance unit
- Flame protection gasket
- Precision-adjustable ventilation valve
- Precision-adjustable inert gas valve with Cross-Flow Technology
- Analog pressure gauge (displays pressure difference between the inner chamber and ambient pressure)
- Micro-polished inner chamber, suction and ventilation tubes, pressure container, expansion racks and ball valve are made of highly corrosion resistant stainless steel V4A
- Door gasket made of tempered silicone
- Independent adjustable temperature safety device class 2 (DIN 12880), with visual temperature alarm
- RS 422 interface for APT-COM™ DataControlSystem communication software
- Two patented, flexible aluminum expansion racks
- Also available as complete system with module and vacuum pump



► VDL SERIES | FAST AND CONDENSATION-FREE DRYING PROCESS:

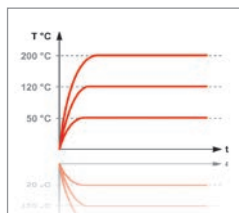

**Process stability for perfect results**

- Innovative control concept for regulation of the entire temperature range without overshooting
  - Short heating up times
  - Easy operation
- APT.line™ preheating chamber
  - Gentle drying throughout the chamber interior
  - Direct heat transfer through large thermal conducting plates
  - Patented, flexible positioning of the expansion racks



**Standards compliant according to ATEX II 3G**

- BINDER safety concept
- Explosion-protected inner chamber in accordance with EX II 3G
- Spring-mounted safety glass panel with shatter protection
- Standard inert glass connection for interior flushing
- Electronic components decoupled from the inner chamber
- Overpressure encapsulated instrument field
- Automatic heating activated < 125 mbar
- Patented flame protection gasket

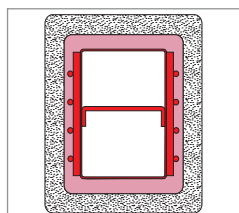

**Accelerated drying process**

- BINDER Cross-Flow Principle
- Even flow throughout the inner chamber from bottom to top
- Finely adjustable inert gas valve without turbulence for lighter samples
- Individually controlled

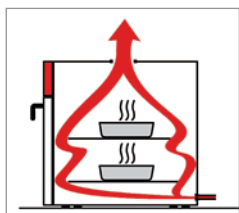

**Simple, time-saving cleaning**

- Smooth inner chamber with rounded corners
- Inner chamber and all connections made of highly corrosion resistant stainless steel V4A
  - Fixtures are fully removable

► **OPTIONS**

- Expansion racks, stainless steel
- Connection kit with various small-flange components
- Measuring port for vacuum-tight access port of measuring lines into the device (9-pin)
- Temperature measurement of the specimen with flexible PT 100 sensor and digital specimen temperature display
- Calibration certificates
- Extension to calibration certificate (additional measuring points)
- Door gasket, FKM (Viton)
- Vacuum module with ATEX chemical membrane pump VP 4
- Vacuum module with ATEX chemical membrane pump VP 5
- Vacuum module for installation of vacuum pumps



BINDER one-stop solution vacuum module with pump



ATEX chemical membrane pump VP 4 (see page 49)



► **BINDER INDIVIDUAL**  
More information from page 90

Vacuum drying oven with custom-made front panel for additional protection against gas leakage

1

2

3

4

5

# Technical data for your planning and installation

## VDL series



	VDL 23	VDL 53	VDL 115
<b>Exterior dimensions</b>			
Width (mm)	515	635	740
Height (inclusive feet) (mm)	655	775	900
Height VDL with option "vacuum module" (mm)	1280	1400	1525
Depth (mm)	500	550	670
Plus door handle, connection (mm)	100	100	100
<b>Interior dimensions</b>			
Width (mm)	285	400	510
Height (mm)	285	400	510
Depth (mm)	295	340	460
Interior volume (l/cu.ft.)	23	53	115
Quantity of expansion racks (aluminum) (standard/max.)	2 / 4	2 / 5	2 / 6
Load per rack (kg/lbs.)	20	20	20
Permitted total load (kg/lbs.)	35	45	65
Weight of the unit (empty) (kg/lbs.)	63	95	153
<b>Temperature data</b>			
Temperature range, 15 °C above ambient up to (°C)	200	200	200
Temperature uniformity at 100 °C (± K) <sup>1)</sup>	1.5	2.0	3.5
Temperature fluctuation (± K) <sup>1)</sup>	0.1	0.1	0.1
Heating-up time to 100 °C (min.) <sup>1) 2)</sup>	65	80	95
Permitted end vacuum (mbar)	0.01	0.01	0.01
Leak rate max. (bar/h)	0.01	0.01	0.01
Compressed air connection for pressure-encapsulation (Ø mm)	8	8	8
<b>Electrical data</b>			
Housing protection acc. to EN 60529	IP 54	IP 54	IP 54
Nominal voltage (±10%) 50/60 Hz (V)	230	230	230
Nominal power (kW)	0.8	1.2	1.9
Energy consumption at 100 °C (W/h)	105	150	250
Energy consumption at 200 °C (W/h)	280	445	785
<b>Model no.</b>	<b>9030-0038</b>	<b>9030-0039</b>	<b>9030-0040</b>

<sup>1)</sup> values measured with aluminum racks // <sup>2)</sup> to 98 % of the set value /// All technical data are specified for units with standard equipment at an ambient temperature of 25 °C and a voltage fluctuation of ±10 %. The temperature data are determined in accordance with factory standard following DIN 12880 respecting the recommended wall clearances of 10 % of the height, width and depth of the inner chamber. All indications are average values, typical for units produced in series. We reserve the right to change technical specifications at any time.

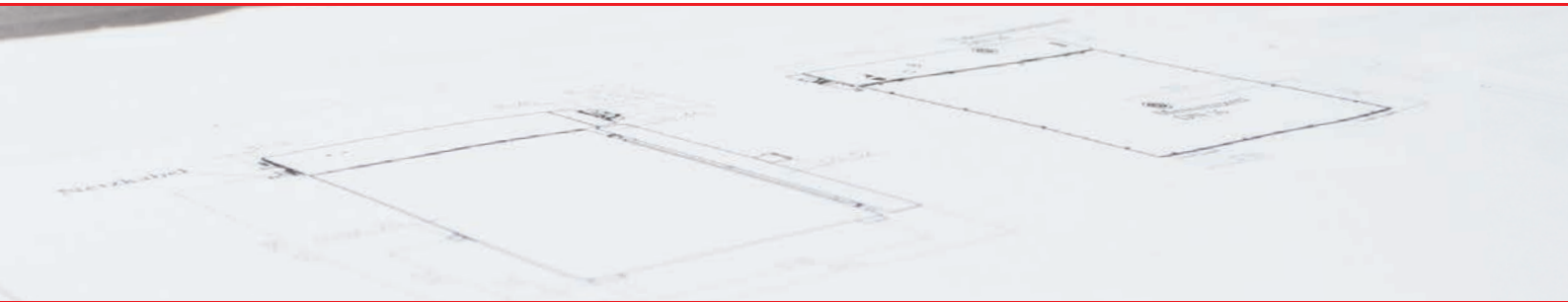

► DIMENSIONS

**VDL 23**

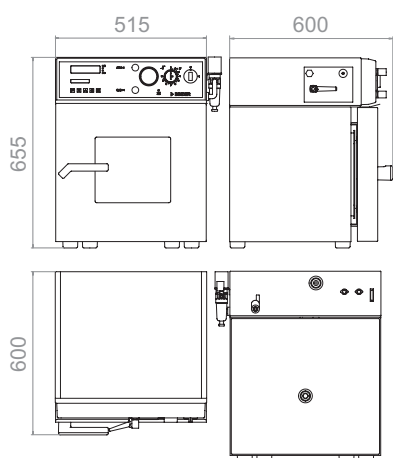

**VDL 53**

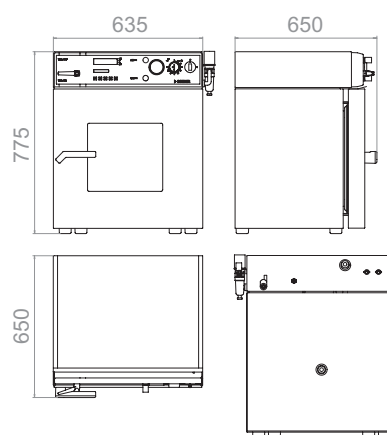

**VDL 115**

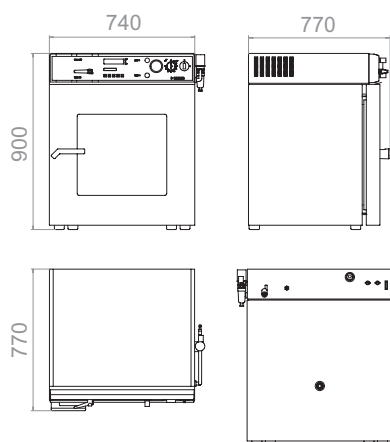

► INSTALLATION REQUIREMENTS

	VDL 23	VDL 53	VDL 115
Nominal voltage ( $\pm 10\%$ ) 50/60 Hz (V)	230	230	230
Nominal power (kW)	0.8	1.2	1.9
Vacuum connection with small flange (DN mm/inch)	16 / 0.63	16 / 0.63	16 / 0.63
Measuring access port with small flange (DN mm/inch)	16 / 0.63	16 / 0.63	16 / 0.63
Inert gas connection with flow limiter (RP")	3 / 8	3 / 8	3 / 8

1

2

3

4

5



# Vacuum module with pump

## VD series

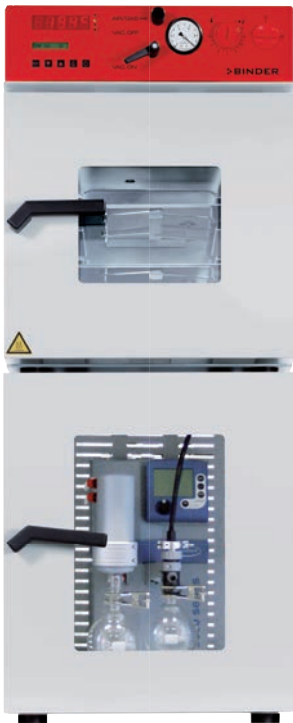

For the VD series, you get an optional separate vacuum module for an ergonomic working height and to reduce noise.

The associated chemical membrane pump is available in three different designs - depending on individual needs. The speed-controlled vacuum pump VP 3.1, for example, adapts to the relevant process cycle and offers up to 30 % time savings.

Additional benefits:

- ▶ Excellent pumping speed even at low pressure
- ▶ Long lifespan due to its oil-free operation
- ▶ Special fluoroplastics provide high chemical resistance



Vacuum module with integrated chemical membrane pump	Vacuum module with chemical membrane pump	Vacuum module with chemical membrane pump	Vacuum module with speed-controlled chemical membrane pump
Type	VP 1.1	VP 2.1	VP 3.1
Nominal airflow	2.0 m <sup>3</sup> /h	3.4 m <sup>3</sup> /h	4.6 m <sup>3</sup> /h
Final pressure	7 mbar	1.5 mbar	1.5 mbar
Electrical connection (50 – 60 Hz)	230 V / 115 V	230 V / 115 V	230 V / 115 V
VD 23 series	•	•	•
VD 53 series	•	•	•
VD 115 series	•	•	•

# Vacuum module with pump

## VDL series



In the vacuum module of the VDL series, there are two different chemical membrane pumps to choose from with different suction capacity and final pressure. Both models are ATEX approved and distinguish themselves by the pressure-capsulated motor with integrated, self-locking overload and overheating protection.

In potentially explosive areas, only ATEX-compliant operating materials may be used since July 1, 2003. All BINDER vacuum pumps for the VDL series are ATEX-compliant.

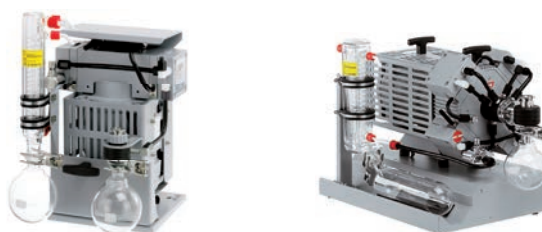

Vacuum module with integrated chemical membrane pump	Vacuum module with chemical membrane pump, explosion protected	Vacuum module with chemical membrane pump, explosion protected
Typ	VP 4	VP 5
ATEX approval according to ATEX 94/9/EC	yes	yes
Nominal airflow	1.9 m³/h	3.7 m³/h
Final pressure	12 mbar	3 mbar
Electrical connection (50 Hz)	230 V	230 V
VDL 23 series	•	–
VDL 53 series	•	–
VDL 115 series	•	•
Application profile	Approved ATEX-compliant Membrane pump for VDL 23 VDL 53 series	Approved ATEX-compliant Membrane pump with low final vacuum for VDL 115 series

1

2

3

4

5



# Safety drying

## FDL | MDL series

### Unconditionally good: BINDER Safety drying ovens

- ▶ Unconditionally accurate
  - ▶ Fast, uniform drying
  - ▶ Wide temperature range up to 350 °C
  - ▶ Low heat dissipation due to 60 mm insulation
  - ▶ Specimen temperature display with temperature sensor
- ▶ Unconditionally safe
  - ▶ Meets EN 1539: Fresh air monitoring with automatic switchoff
  - ▶ Safety class IP 33
  - ▶ Hermetic door with 2-points door closure
- ▶ Unconditionally versatile
  - ▶ Extension for coil coating test available for MDL series
  - ▶ Digital multi-program controller
  - ▶ Communication interface

For the perfect finish to your solvent-based paints and coating materials, we offer you two series. Absolute temperature accuracy with a high air exchange rate and thus the basis for the best results qualitatively and reproducible tests. You can work safely at all times thanks to replaceable fresh air cartridges and electronic monitoring.



Paint industry



Seal manufacturers



Chemical industry

# Safety drying ovens

## FDL series

This series provides the perfect environment for all specimens containing solvents: the high efficiency filter cartridge and symmetric airflow provide a silicone free and dust-free inner chamber. The FDL meets all EN 1539 requirements and also ensures maximum work safety with the intelligent fresh air monitoring program.



► FDL 115 model



115

Available size (liters)

### ► EQUIPMENT

- All safety features compliant with EN 1539
- Temperature range from 5 °C above ambient temperature to 300 °C
- MP controller with 2 programs with 10 sections each, or alternatively one program with 20 sections
- The time of an individual program step can be set to max. 999 hours and 59 minutes
- Integrated weekly program timer with real-time function
- Digital temperature setting with an accuracy of one or a tenth of a degree
- Elapsed time indicator
- Door gasket made of FKM (up to max. 200 °C)
- Replaceable fresh-air filter cartridge, class F6 (EU6 fine particle filter for particle sizes between 1 µm and 10 µm)
- Independent adjustable temperature safety device class 2 (DIN 12880), with audible and visual alarm
- Fresh-air monitoring with audible and visual alarm and automatic deactivation of heating
- Rear exhaust connector Ø 100 mm
- RS 422 interface for APT-COM™ DataControlSystem communication software
- Two chrome-plated racks included

► FDL SERIES | BEST TEST RESULTS:

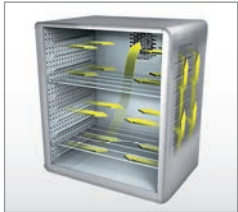

**Uniform test conditions**

- APT.line™ preheating chamber
  - Homogeneous temperature distribution
  - Identical test conditions throughout the chamber interior independent of sample size and quantity

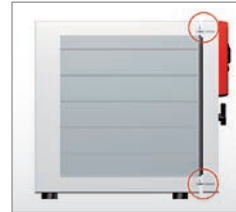

**Convenient work environment**

- Hermetic door closure with 2-points door closure
- Low heat dissipation due to 60 mm insulation
- Rack with tilt protection
- Complete stainless steel inner chamber
- No permanent fixtures
- Silicone free



**Maximum work safety**

- Defined solvent quantity meets drying safety standards
- EN 1539 compliant: Fresh air monitoring with automatic switchoff
- Safety class IP 33
- Easy to replace fresh air filter

► OPTIONS

- Access ports, Ø 10 mm, Ø 30 mm, right, left
- Racks, chrome-plated or stainless steel
- Perforated shelf, stainless steel
- Specimen temperature display with temperature sensor and analog output 4 – 20 mA
- Replacement air filter (class F6/EU6 for particle sizes between 1 µm and 10 µm)
- Door lock
- Door gasket made of silicone for applications > 200 °C
- Calibration certificate, measurement in center
- Extension to factory calibration certificate (additional measuring point)
- Temperature measurement according to DIN 12880

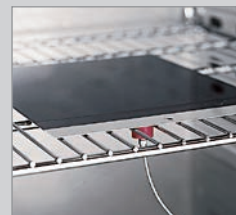

Temperature measurement of the specimen

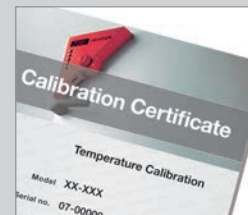

Calibrations and validations



Various access ports



Safety drying oven with UV lamp for testing UV resistance

► **BINDER  
INDIVIDUAL**  
More information  
from page 90

# Technical data for your planning and installation

## FDL series



FDL 115	
<b>Exterior dimensions</b>	
Width (mm)	835
Height (inclusive feet) (mm)	800
Depth (mm)	685
Plus door handle, I-panel and exhaust duct (mm)	50
<b>Interior dimensions</b>	
Width (mm)	600
Height (mm)	435
Depth (mm)	435
Interior volume (l)	115
Quantity of racks (standard/max.)	2 / 5
Load per rack (kg)	20
Permitted total load (kg)	50
Weight of the unit (empty) (kg)	90
<b>Temperature data</b>	
Temperature range, 5 °C above ambient up to (°C)	300
Temperature uniformity at 150 °C (± K)	2.5
Temperature fluctuation at 150 °C (± K)	0.3
Heating-up time at 150 °C (min.) <sup>1)</sup>	17
Recovery time after door was opened for 30 sec. at 150 °C (min.) <sup>1)</sup>	3
Air change (approx. x/min.)	3
Air circulation (approx. x/min.)	40
Exhaust air volume flow (approx. l/Min. m <sup>3</sup> /h)	400 (24,0)
Air flow velocity (m/sec)	0.8 – 1.2
Highest permitted solvent quantity (g) (at T-180 °C, M-100 g/mol, U-40 g/m <sup>3</sup> , K=0,5)	6.65
<b>Electrical data</b>	
Housing protection acc. to EN 60529	IP 33
Nominal voltage (±10%) 50/60 Hz (V)	230
Nominal power (kW)	2.9
Energy consumption at 150 °C (W)	1098
<b>Model no.</b>	<b>9010-0269</b>

<sup>1)</sup> to 98 % of the set value /// All technical data are specified for units with standard equipment at an ambient temperature of 25 °C and a voltage fluctuation of ±10 %. The temperature data are determined in accordance with factory standard following DIN 12880 respecting the recommended wall clearances of 10 % of the height, width and depth of the inner chamber. All values have been specified at a fan speed of 100%. All indications are average values, typical for units produced in series. We reserve the right to change technical specifications at any time.

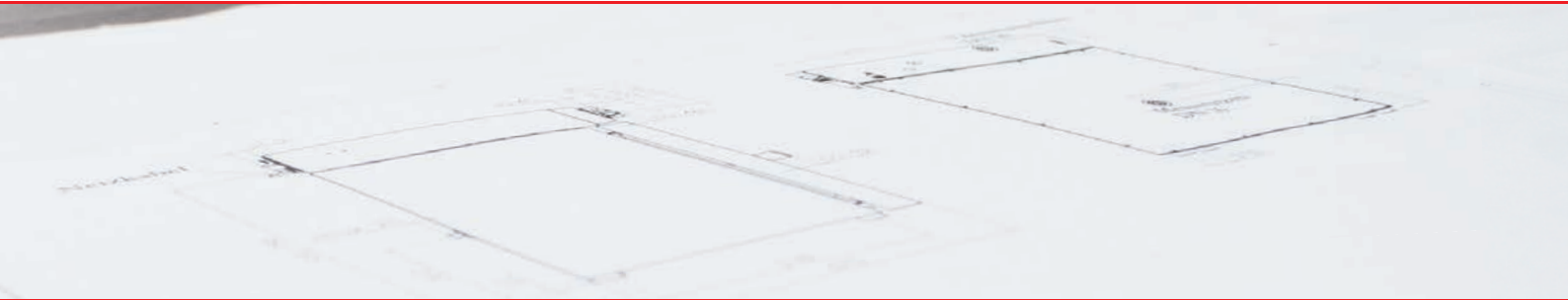

► DIMENSIONS

**FDL 115**

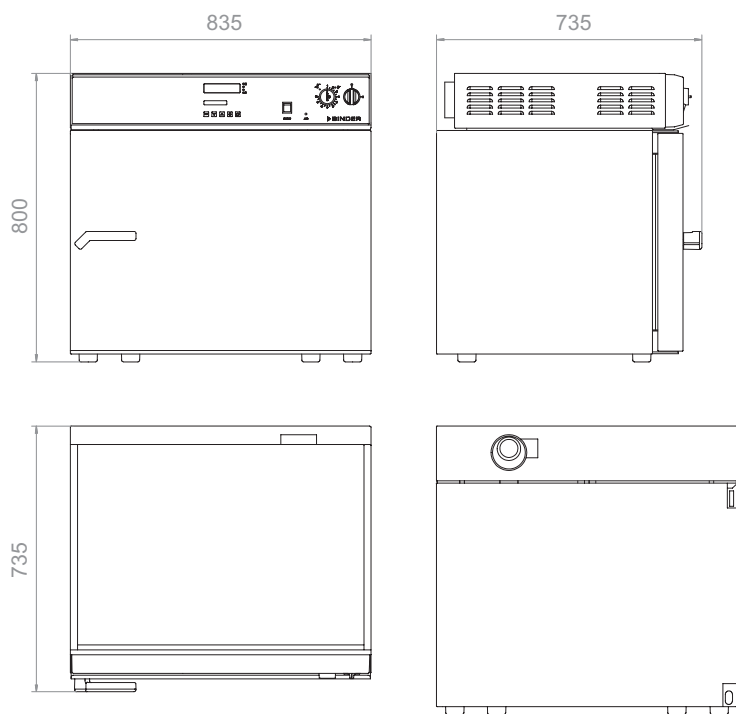

1

2

3

4

5

► INSTALLATION REQUIREMENTS

	FDL 115
Nominal voltage (+10 %) 50/60 Hz (V)	230
Nominal power (kW)	2.9



# Safety drying ovens with expanded temperature range

## MDL series

The MDL series works at temperatures up to 350 °C and at an extremely high airflow rate. It is perfectly suited for high-temperature testing such as in the coil coating testing sector. The preheating chamber technology with special airflow design allows evenly distributed burn-in over a very short period – and all that with maximum work safety due to electronic fresh air monitoring. The customized programming also gives you all the freedom you need for your work.



► MDL 115 model



115

Available size (liters)

### ► EQUIPMENT

- Compliant with all EN 1539 safety requirements
- Temperature range from 5 °C above ambient temperature to 350 °C
- MCS controller which can store 25 programs of 100 sections each for a maximum of 500 program segments
  - User-friendly LCD screen
  - Easy-to-read menu guidance
  - Integrated electronic chart recorder
  - Variety of options for the graphic display of process parameters
  - Real-time clock
- Heating output 9.0 kW
- Door gasket made of high temperature resistant silicone
- Rear exhaust connector Ø 100 mm
- Replaceable fresh-air filter cartridge, class F6 (EU6 fine particle filter for particle sizes between 1 µm and 10 µm)
- Independent adjustable temperature safety device class 2 (DIN 12880), with audible and visual alarm
- Fresh-air monitoring with audible and visual alarm and automatic heating feature deactivation
- RS 422 interface for APT-COM™ DataControlSystem communication software
- Two chrome-plated racks included

► MDL SERIES | BEST TEST RESULTS:

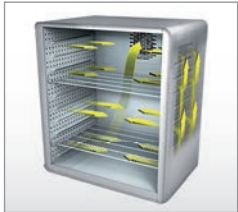

**Uniform test conditions**

- APT.line™ preheating chamber
  - Homogeneous temperature distribution
  - Identical test conditions throughout the chamber interior independent of sample size and quantity

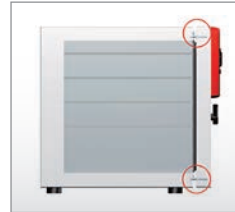

**Convenient work environment**

- Hermetic door closure with 2-points door closure
- Low heat dissipation due to 60 mm insulation
- Rack with tilt protection
- Complete stainless steel inner chamber
- No permanent fixtures



**Maximum work safety**

- Defined solvent quantity meets drying safety standards
- EN 1539 compliant: Fresh air monitoring with automatic switchoff
- Safety class IP 33
- Easy to replace fresh air filter



**Custom programming**

- Controller with color display which can store 25 programs
- Integrated digital continuous-line recorder for monitoring limits and alarm function
- Convenient documentation
- All measured values read at a glance

► **OPTIONS**

- Racks, chrome-plated or stainless steel
- Perforated shelf, stainless steel
- Extension in the door for coil coating tests
- Replacement air filter (class F6/EU6 for particle sizes between 1 µm and 10 µm)
- Additional measuring channel for digital display of specimen temperature with clip temperature sensor
- Door lock
- Lockable controller keyboard
- Calibration certificate, measurement in center
- Extension to factory calibration certificate (additional measuring point)
- Temperature measurement according to DIN 12880

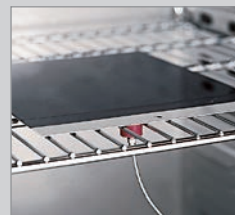

Temperature measurement of the specimen



Extension for coil coating applications



Calibrations and validations



Safety drying oven with HEPA fresh-air filter EU 14

► **BINDER  
INDIVIDUAL**  
More information  
from page 90

1

2

3

4

5

# Technical data for your planning and installation

## MDL series



MDL 115	
<b>Exterior dimensions</b>	
Width (mm)	835
Height (inclusive feet) (mm)	800
Depth (mm)	685
Plus door handle, I-panel and exhaust duct (mm)	50
<b>Interior dimensions</b>	
Width (mm)	600
Height (mm)	435
Depth (mm)	435
Interior volume (l)	115
Quantity of racks (standard/max.)	2 / 5
Load per rack (kg)	20
Permitted total load (kg)	50
Weight of the unit (empty) (kg)	90
<b>Temperature data</b>	
Temperature range, 5 °C above ambient up to (°C)	350
Temperature uniformity at 150 °C (± K)	3.4
Temperature fluctuation at 150 °C (± K)	0.5
Heating-up time at 150 °C (Min.) <sup>1)</sup>	6
Recovery time after door was opened for 30 sec. at 150 °C (min.)	2
Air change (approx. x/min.)	3
Air circulation (approx. x/min.)	40
Exhaust air volume flow (approx. l/min. m <sup>3</sup> /h)	400 (24,0)
Air flow velocity (m/sec)	0.8 – 1.2
Highest permitted solvent quantity (g) (at T-180 °C, M-100g/mol, U-40g/m <sup>3</sup> , K=0,5)	6.65
<b>Electrical data</b>	
Housing protection acc. to EN 60529	IP 33
Nominal voltage (±10%) 50/60 Hz (V)	400 V / 3N~
Nominal power (kW)	9
Energy consumption at 150 °C (W)	1130
<b>Model no.</b>	
	9010–0200

<sup>1)</sup> to 98 % of the set value /// All technical data are specified for units with standard equipment at an ambient temperature of 25 °C and a voltage fluctuation of ±10 %. The temperature data are determined in accordance with factory standard following DIN 12880 respecting the recommended wall clearances of 10 % of the height, width and depth of the inner chamber. All values have been specified at a fan speed of 100%. All indications are average values, typical for units produced in series. We reserve the right to change technical specifications at any time.

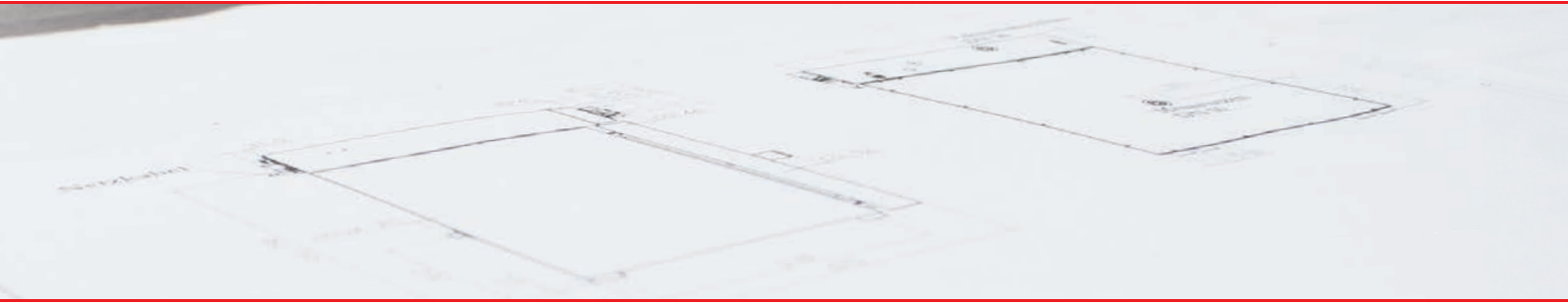

► DIMENSIONS

**MDL 115**

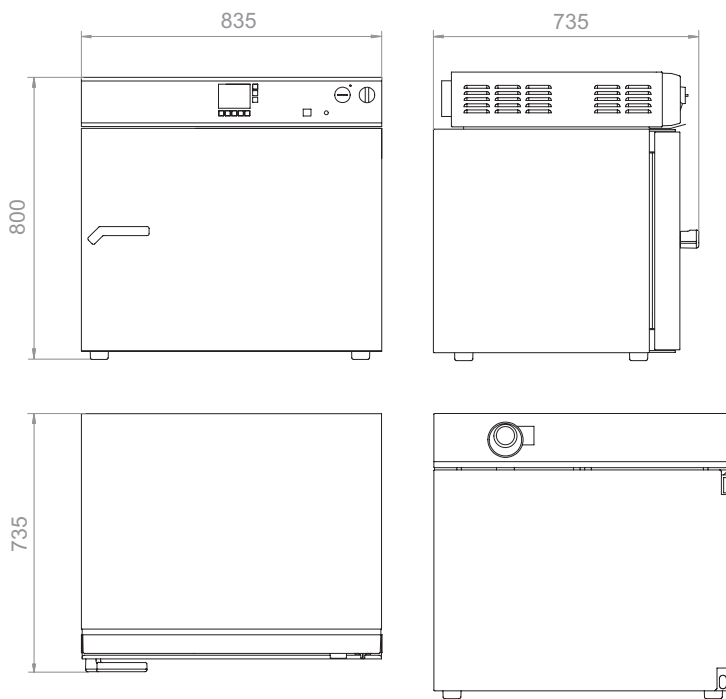

1

2

3

4

5

► INSTALLATION REQUIREMENTS

	MDL 115
Nominal voltage ( $\pm 10\%$ ) 50/60 Hz (V)	400 V / 3N~
Nominal power (kW)	9



# Environmental simulation

## | Always the right climate

Research and quality assurance is solely focused on the optimization and monitoring of the performance standards, of functions and service life of materials, products and systems. It is expected from a climate chamber that it simulates the effects of temperature, humidity and light on the chemical, physical and biological behavior of the test material in a reproducible manner.

BINDER offers several series of constant climate chambers specifically designed for these demanding requirements. They provide innovative technical solutions and comprehensive equipment options, with which specimens can be safely and reliably tested, whether actively or passively. For special technical requirements, users can also rely on the individually tailored solutions from BINDER INDIVIDUAL.

### Alternating temperature and climate testing

MK | MKT  
MKF | MKFT

Page 62

### Dynamic constant climate testing

KMF

Page 80

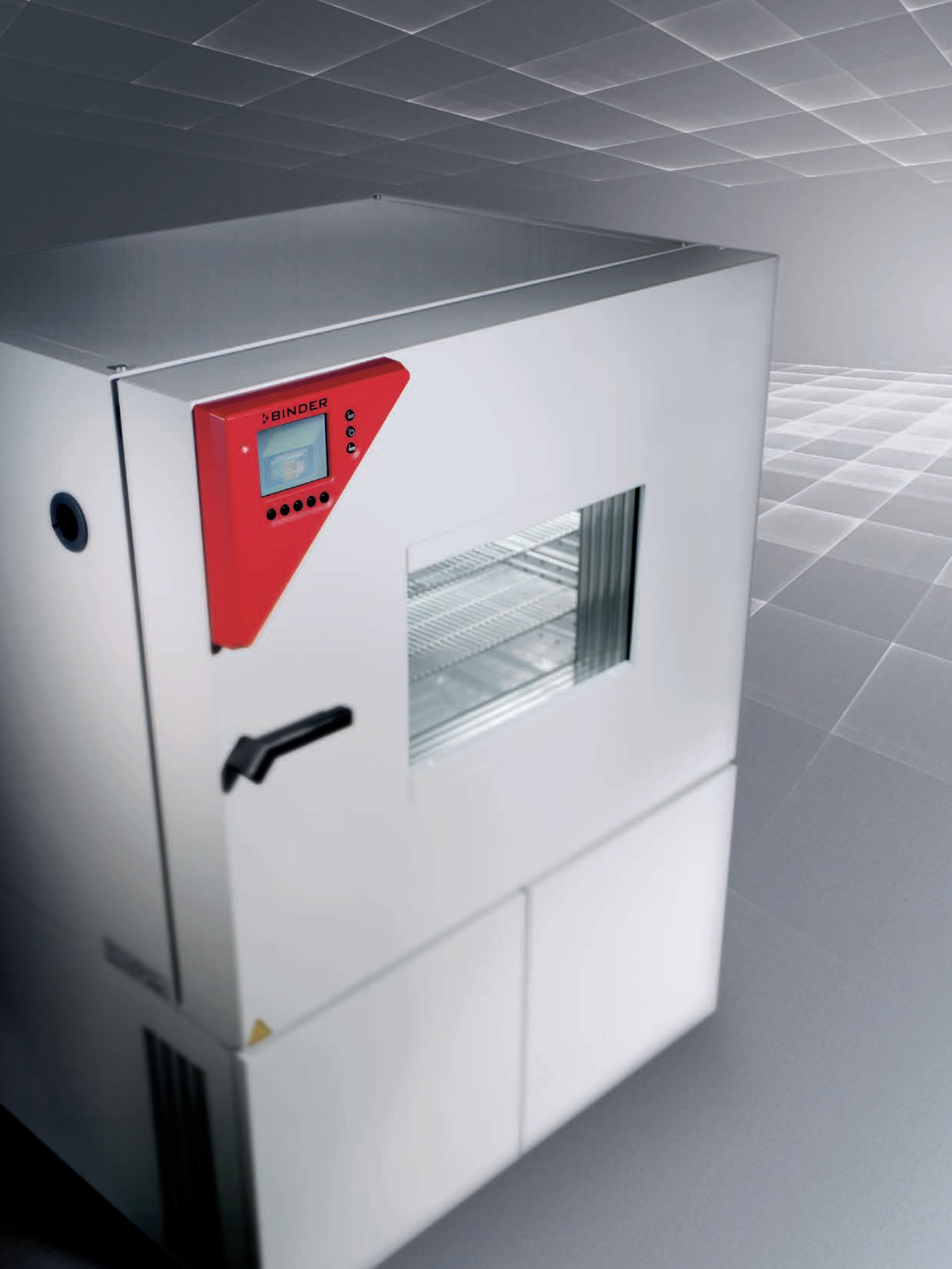

# Alternating temperature and climate testing

## MK | MKT | MKF | MKFT series

### Diverse climate profiles: Environmental simulation chambers

- ▶ Complete reliability
  - ▶ Dynamic alternating climate change of 10% – 98% RH
  - ▶ Rapid temperature change up to 5 K/min.
  - ▶ Fulfillment of most current and individual testing standards, e.g. PV 1200
  - ▶ Responsive vapor pressure humidification
  - ▶ Test chamber sizes of 53 to 720 liters
  
- ▶ Comprehensive control
  - ▶ Complete data logging with validation documents
  - ▶ Viewing window standard
  
- ▶ Wide range of applications
  - ▶ Easy to handle and operate
  - ▶ Water supply independent of location
  - ▶ Generous standard equipment

The MK and MKT series are the ideal simulation chambers for all heat or cold testing cycles. The MKF and MKFT series safely fulfill complex alternating climate profiles in accordance with testing standards. The APT.line™ airflow design, responsive vapor pressure and humidification system ensure perfect test conditions. The high-class products are used in applications that involve complex standardized environmental testing.



Building supplier industry



Electronics industry



Aerospace technology



# Environmental simulation chambers for cyclic temperature testing

## MK | MKT series

The MK and MKT series master all heating and cooling tests between -70 °C and 180 °C. They distinguish themselves through precision and performance. The APT.line™ preheating chamber technology ensures natural simulation – and thus reliable test results.



► MKT 240 model

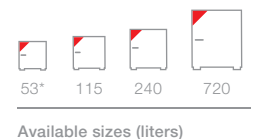

### ► EQUIPMENT

- Temperature range of -40 °C to 180 °C (MK) and -70 °C to 180 °C (MKT)
- MCS controller with 25 storable programs of 100 sections each for a maximum of 500 program segments
  - User friendly LCD screen
  - Easy-to-read menu guide
  - Integrated electronic chart recorder
  - Variety of options for the graphic display of process parameters
  - Real time clock
- Programmable condensation protection for test material
- 230 V power socket on the right-side operating panel (except MK 53)
- Adjustable ramp function via program editor
- Access port Ø 80 mm top (MK 53), Ø 50 mm, left side (MK 115, 240), 2 access ports Ø 80 mm, right and left side (MK 720)
- Temperature safety device class 2 (DIN 12880) with visual and acoustic temperature alarm
- Heated viewing window with LED interior lighting
- Ethernet for GLP/GMP and FDA guideline 21 CFR Part 11 compliant APT-COM™ DataControlSystem software
- Stainless steel rack included
- 4 castors (2 with brakes) (except MK 53)

► MK | MKT SERIES | BEST TEST CONDITIONS:

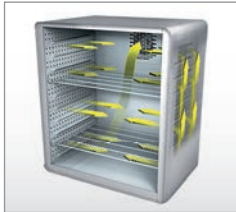

**Homogeneous climate conditions**

- ▶ APT.line™ for uniform circulation even under full load
- ▶ Same test conditions throughout the chamber interior
- ▶ Independent of specimen size and quantity



**Comprehensive product portfolio**

- ▶ BINDER Data Logger Kits
- ▶ Years of proven and recognized validation and documentation materials
- ▶ Customized solutions

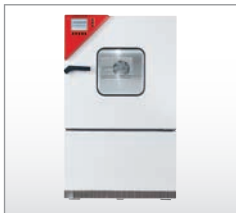

**Well equipped**

- ▶ Heated viewing window
- ▶ Rugged chassis with castors from 115 liters
- ▶ Ethernet interface
- ▶ Documentation Software APT-COM™



**Convenient assembly and operation**

- ▶ Large access area
- ▶ Controls accessible from the front
- ▶ Optimum use of space

► **OPTIONS**

- Notch-type access port in the door, 100 x 35 mm
- Data Logger Kits and software
- Shelf, stainless steel
- Perforated shelf, stainless steel
- Reinforced shelf, stainless steel
- Locking of controller keyboard
- Lockable door
- Safety device for over and under temperature (DIN 12880)
- Analog outputs 4 to 20 mA with DIN bushing 6 poles
- Additional measuring channel for specimen temperature display
- Qualification folder
- Calibration certificate
- Extension for calibration certificate



Reinforced shelves



Notch-type access port in door



Various access ports



MK with door openings for manual access during test conditions

► **BINDER  
INDIVIDUAL**  
More information  
from page 90

# Technical data for your planning and installation MK series



	MK 53	MK 115	MK 240	MK 720
<b>Exterior dimensions</b>				
Width (mm)	745	1000	1135	1615
Height (including feet/casters) (mm)	1245	1725	1715	2005
Depth (including door handle, I-panel and exhaust duct) (mm)	795	915	1000	1230
<b>Interior dimensions</b>				
Width (mm)	400	600	735	1200
Height (mm)	400	480	700	1020
Depth (mm)	330	400	445	600
Interior volume (l)	53	115	228	734
Quantity of racks (standard/max.)	1 / 5	1 / 4	1 / 6	1 / 11
Load per rack (kg)	15	30	30	40
Permitted total load (kg)	40	60	70	160
Weight (empty) (kg)	150	260	340	570
<b>Temperature data</b>				
Temperature range (°C) <sup>1)</sup>	-40 – 180	-40 – 180	-40 – 180	-40 – 180
Temperature uniformity (± K) <sup>2)</sup>	0.4 – 2.0	0.1 – 2.0	0.1 – 1.2	0.3 – 2.0
Temperature fluctuation (± K) <sup>2)</sup>	0.1 – 0.5	0.1 – 0.5	0.1 – 0.5	0.1 – 0.5
Mean heating-up rate from -40 °C to 180 °C acc. to factory standard (K/min.)	4.6	5.3	5.0	4.0
Mean cooling rate from 180 °C to -40 °C acc. to factory standard (K/min.)	4.1	5.0	4.5	4.5
Max. heat compensation (kW)	0.5	2.0	2.0	6.5
<b>Electrical data</b>				
Housing protection acc. to EN 60529	IP 20	IP 20	IP 20	IP 20
Nominal voltage (±10%) 50 Hz (V)	230 1 N ~	400 3 N ~	400 3 N ~	400 3 N ~
Nominal power (kW)	2.6	3.5	4.2	7.2
Energy consumption at 20 °C (kW) <sup>3)</sup>	1.02	0.65	1.30	1.90
Noise level (ca. dB(A))	59	62	62	65
<b>Model no.</b>	<b>9020-0006</b>	<b>9020-0175</b>	<b>9020-0181</b>	<b>9020-0197</b>

## ▶ HEATING UP AND COOLING DOWN RATE

### MK 53

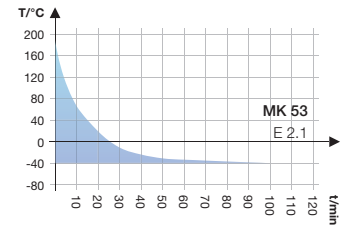
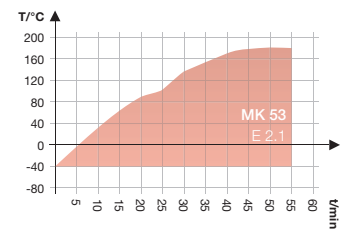

## ▶ HEAT COMPENSATION

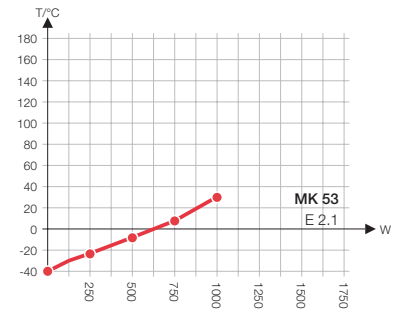

## ▶ DIMENSIONS

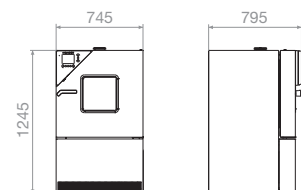

<sup>1)</sup> Lower values are valid up to an ambient temperature of max. 25 °C / 77 °F // <sup>2)</sup> depending on the set point. // <sup>3)</sup> Use this value for dimensioning air conditioning systems. /// The temperature data are determined in accordance with factory standard following DIN 12880 respecting the recommended wall clearances of 10 % of the height, width and depth of the inner chamber. All values have been specified at a fan speed of 100%. All indications are average values, typical for units produced in series. We reserve the right to change technical specifications at any time.

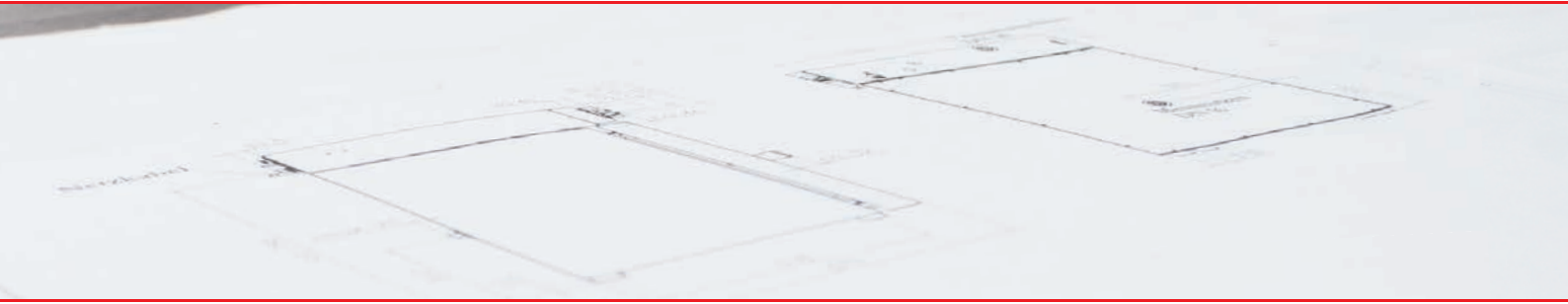

► HEATING UP AND COOLING DOWN RATE

**MK 115**

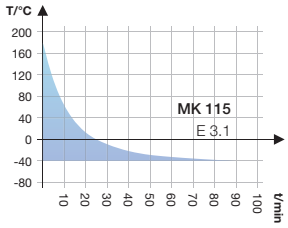
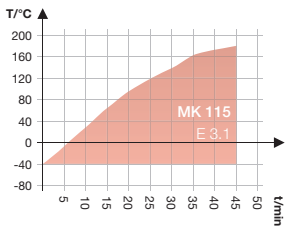

**MK 240**

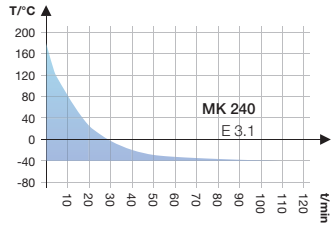
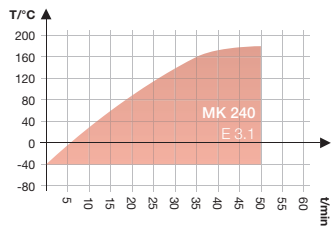

**MK 720**

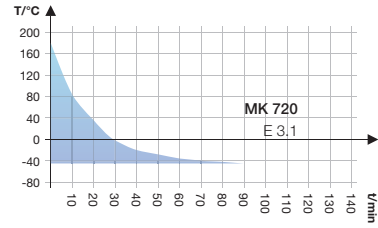
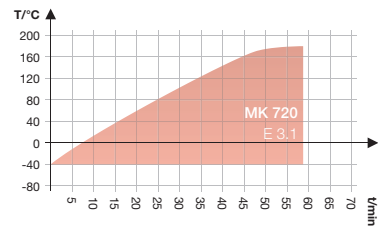

► HEAT COMPENSATION

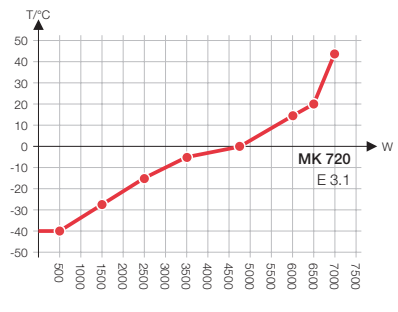
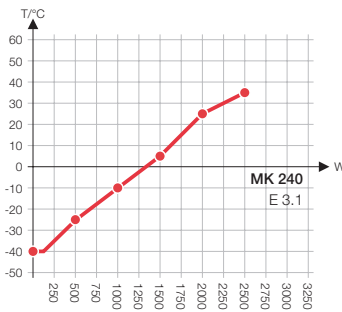
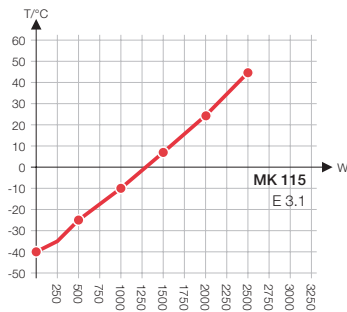

► DIMENSIONS

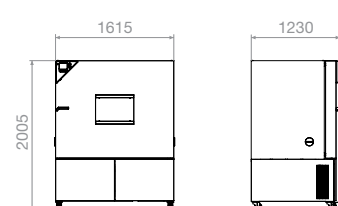
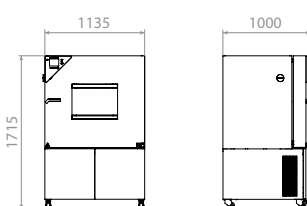
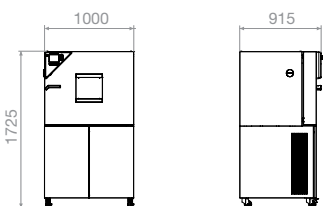

- 1
- 2
- 3
- 4
- 5

# Technical data for your planning and installation

## MKT series



	MKT 115	MKT 240	MKT 720
<b>Exterior dimensions</b>			
Width (mm)	1000	1135	1615
Height (including feet/casters) (mm)	1725	1940	2005
Depth (including door handle, I-panel and exhaust duct) (mm)	915	1000	1230
<b>Interior dimensions</b>			
Width (mm)	600	735	1200
Height (mm)	480	700	1020
Depth (mm)	400	445	600
Interior volume (l)	115	228	734
Quantity of racks (standard/max.)	1 / 4	1 / 6	1 / 11
Load per rack (kg)	30	30	40
Permitted total load (kg)	60	70	160
Weight (empty) (kg)	305	380	610
<b>Temperature data</b>			
Temperature range (°C) <sup>1)</sup>	-70 – 180	-70 – 180	-70 – 180
Temperature uniformity (± K) <sup>2)</sup>	0.2 – 1.8	0.1 – 1.0	0.3 – 2.0
Temperature fluctuation (± K) <sup>2)</sup>	0.1 – 0.6	0.1 – 0.4	0.1 – 0.5
Mean heating-up rate from -40 °C to 180 °C acc. to factory standard (K/min.)	5.3	5.0	4.5
Mean cooling rate from 180 °C to -40 °C acc. to factory standard (K/min.)	4.2	4.2	4.2
Max. heat compensation (kW)	1.8	3.0	5.5
<b>Electrical data</b>			
Housing protection acc. to EN 60529	IP 20	IP 20	IP 20
Nominal voltage (±10%) 50 Hz (V)	400 3 N ~	400 3 N ~	400 3 N ~
Nominal power (kW)	5.5	6.5	13.0
Energy consumption at 20 °C (kW) <sup>1)</sup>	0.8	1.4	2.2
Noise level (ca. dB(A))	64	64	65
<b>Model no.</b>	<b>9020-0151</b>	<b>9020-0196</b>	<b>9020-0082</b>

### ► EXCERPT FROM FULFILLED STANDARDS

DIN EN 60068-2-2:2008-05

DIN EN 60068-2-14:2010-09

DIN EN 60068-3-5:2002-12

DIN EN 61215:2006-2, 10.11

DIN EN 61646:2009-03, 10.11

For standards with description, see page 4.

<sup>1)</sup> Lower values are valid up to an ambient temperature of max. 25 °C / 77 °F // <sup>2)</sup> depending on the set point. /// All technical data are specified for units with standard equipment at an ambient temperature of 25 °C and a voltage fluctuation of ±10 %. The temperature data are determined in accordance with factory standard following DIN 12880 respecting the recommended wall clearances of 10 % of the height, width and depth of the inner chamber. All values have been specified at a fan speed of 100%. All indications are average values, typical for units produced in series. We reserve the right to change technical specifications at any time.

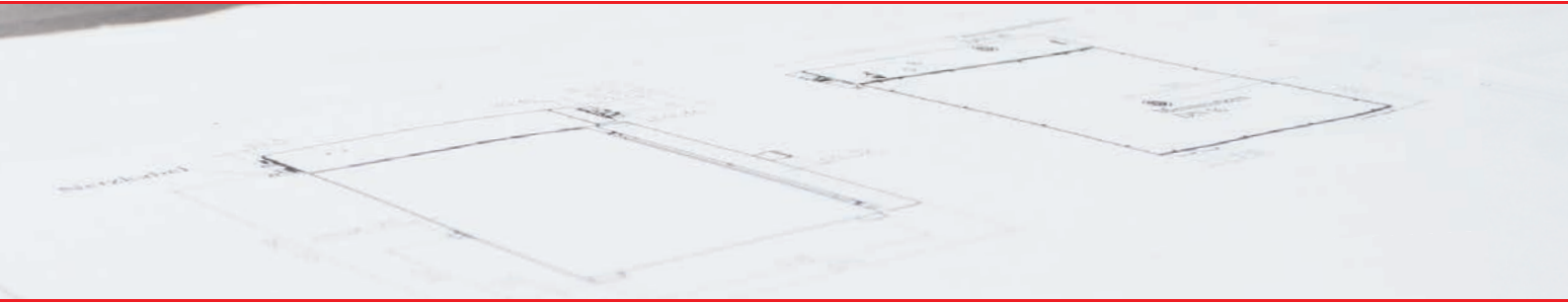

► HEATING UP AND COOLING DOWN RATE

**MKT 115**

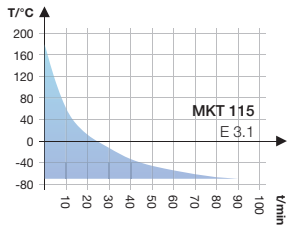
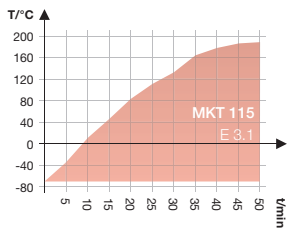

**MKT 240**

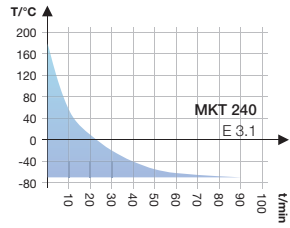
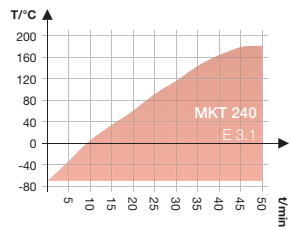

**MKT 720**

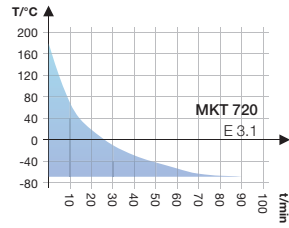
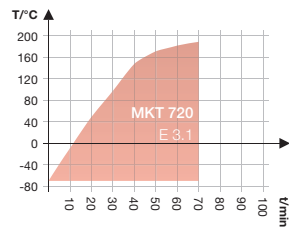

► HEAT COMPENSATION

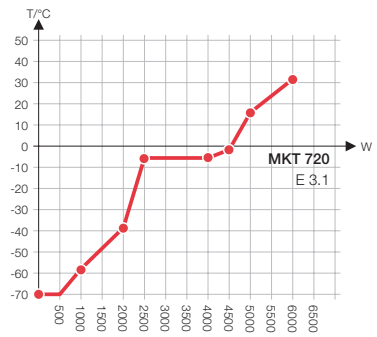
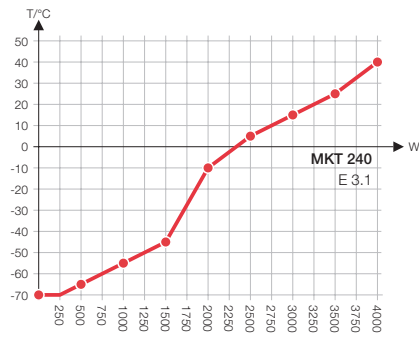
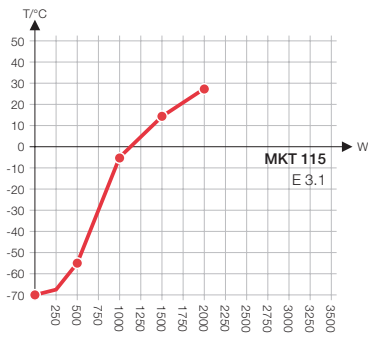

► DIMENSIONS

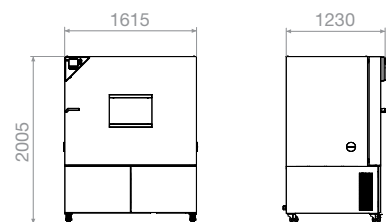
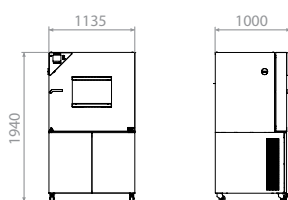
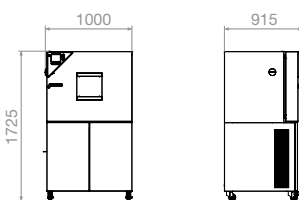

# Climate test chambers for complex alternating climate profiles

## MKF | MKFT series

The MKF and MKFT series meet the requirements based on EN, IEC, MIL standards and several tests derived from these standards. The required temperature and humidity values are quickly achieved and accurately maintained thanks to high dynamics. This guarantees exact measurement results at any time.



► MKF 240 model

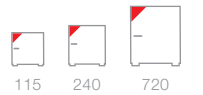

Available sizes (liters)

### ► EQUIPMENT

- Temperature range of -40 °C to 180 °C (MKF) and -70 °C to 180 °C (MKFT)
- Humidity range 10% r.H. to 98% r.H.
- MCS controller with 25 storable programs of 100 sections each for a maximum of 500 program segments
  - User friendly LCD screen
  - Easy-to-read menu guide
  - Integrated electronic chart recorder
  - Variety of options for the graphic display of process parameters
  - Real time clock
- Electronically controlled humidification and dehumidification system with capacitive humidity sensor and pressurized steam
- Integrated water storage tank
- Heated viewing window with interior illumination
- Programmable condensation protection for test material
- Adjustable ramp functions via program editor
- 230 V power socket on the right-side operating panel
- Temperature safety device, Class 2 (DIN 12880) with visual and acoustic temperature alarm
- 4 potential-free relay outputs that can be activated via MCS controller
- Ethernet interface for use with APT-COM™ DataControlSystem software
- 1 access port Ø 50 mm, left side
- Stainless steel rack include
- 4 castors (2 with brakes)

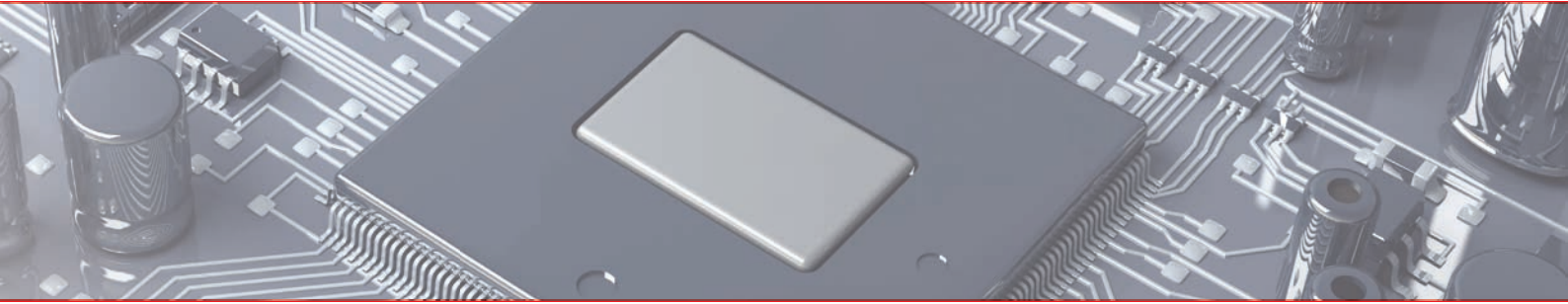

► **MKF | MKFT SERIES | BEST MEASUREMENT RESULTS:**

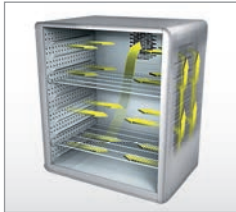

**Homogeneous climate conditions**

- ▶ APT.line™ for uniform circulation even under full load
- ▶ Same test conditions throughout the chamber interior
- ▶ Independent of specimen size and quantity



**Convenient assembly and additional services**

- ▶ Large access area
- ▶ Optimum use of space
- ▶ BINDER Data Logger Kits
- ▶ Validation and documentation materials



**Optimally humidification system**

- ▶ Fast response times thanks to Vapor pressure humidification
- ▶ Drift-free, capacitive humidity sensor for very accurately measured values
- ▶ Minimal maintenance requirements
- ▶ Sewage pump for discharges up to 1 m in height



**Water cooling**

- ▶ Reduced energy consumption
- ▶ Faster switching rates possible
- ▶ Improved heat compensation
- ▶ Reduced waste heat from the unit to the environment
- ▶ Can be retrofitted on site



**Well equipped**

- ▶ Heated viewing window
- ▶ Rugged chassis with castors from 115 liters
- ▶ Ethernet interface
- ▶ Documentation Software APT-COM™
- ▶ Controls accessible from the front

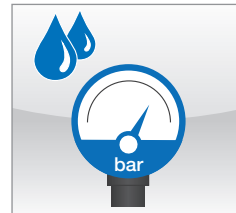

**Regulated compressed-air dryer**

- ▶ Expanded climate ranges
- ▶ Standardized testing as specific points can be tested (see page 76)
- ▶ Dew point down to -30 °C

► **OPTIONS**

- Access port with silicone plug
- Water cooling (MKF)
- Regulated compressed-air dryer (MKF 720)
- Notch-type access port in the door, 100 x 35 mm
- Data Logger Kits and software
- Shelf, stainless steel
- Perforated shelf, stainless steel
- Reinforced shelf, stainless steel
- Locking of controller keyboard
- RS 422 interface
- Lockable door
- Safety device for over and under temperature (DIN 12880)
- Analog outputs 4 to 20 mA with DIN bushing 6 poles
- Additional measuring channel for specimen temperature display
- BINDER PURE AQUA SERVICE
- Disposable cartridge for BINDER PURE AQUA SERVICE
- Qualification folder
- Calibration certificate
- Extension for calibration certificate



Reinforced shelves



BINDER PURE AQUA SERVICE



Notch-type access port in door



MKF with reinforced inner chamber and solidly mounted perforated shelves for very heavy test specimens

► **BINDER INDIVIDUAL**  
More information from page 90



# Technical data for your planning and installation

## MKF series



	MKF 115	MKF 240	MKF 720
<b>Exterior dimensions</b>			
Width (mm)	1000	1135	1615
Height (including feet/casters) (mm)	1725	1715	2005
Depth (including door handle, I-panel and exhaust duct) (mm)	915	1000	1230
<b>Interior dimensions</b>			
Width (mm)	600	735	1200
Height (mm)	480	700	1020
Depth (mm)	400	445	600
Interior volume (l)	115	228	734
Quantity of racks (standard/max.)	1 / 4	1 / 6	1 / 11
Load per rack (kg)	30	30	40
Permitted total load (kg)	60	70	160
Weight (empty) (kg)	280	360	590
<b>Temperature data without humidity</b>			
Temperature range (°C) <sup>1)</sup>	-40 – 180	-40 – 180	-40 – 180
Temperature uniformity (± K) <sup>2)</sup>	0.1 – 1.3	0.1 – 1.5	0.1 – 0.5
Temperature fluctuation (± K) <sup>2)</sup>	0.1 – 0.6	0.1 – 0.5	0.1 – 1.8
Mean heating-up rate from -40 °C to 180 °C acc. to factory standard (K/min.)	5.5	5.0	4.8
Mean cooling rate from 180 °C to -40 °C acc. to factory standard (K/min.)	4.5	5.0	4.8
Max. heat compensation (kW)	2.5	2.8	6.5
<b>Climatic data</b>			
Temperature range (°C)	10 – 95	10 – 95	10 – 95
Temperature fluctuation (± K)	0.1 – 1.3	0.1 – 1.3	0.2 – 1.5
Humidity range (% r.H.)	10 – 98	10 – 98	10 – 98
Humidity fluctuation (± % r.H.)	≤ 2.5	≤ 2.5	≤ 2.5
Max. heat compensation to 25 °C / 90% r.H. (kW)	0.4	0.4	1
<b>Electrical data</b>			
Housing protection acc. to EN 60529	IP 20	IP 20	IP 20
Nominal voltage (±10%) 50 Hz (V)	400 3 N ~	400 3 N ~	400 3 N ~
Nominal power (kW)	4.5	6.8	11.0
Energy consumption at 25 °C / 60% r.H. (kW)	1.25	1.50	3.90
Noise level (ca. dB(A))	62	65	65
<b>Model no.</b>			
	9020-0107	9020-0183	9020-0198

### EXCERPT FROM FULFILLED STANDARDS

DIN EN 60068-2-30:2006-06	DIN EN 61215:2006-02, 10.12
DIN EN 60068-2-38:2010-06	DIN EN 61215:2006-02, 10.13
DIN EN 60068-2-66:1995-06	DIN EN 61646:2009-03, 10.11
DIN EN 60068-2-78:2010-10	DIN EN 61646:2009-03, 10.12
DIN EN 60068-3-5:2002-12	DIN EN 61646:2009-03, 10.13
DIN EN 61215:2006-02, 10.11	MIL STD 810:2000-01

For standards with description, see page 4.

### TEMPERATURE-HUMIDITY CHART

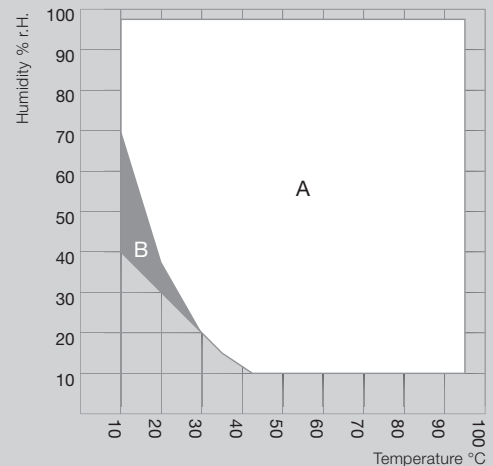

A: Standard Climate range

B: Temporary usable space (up to 24 h)

<sup>1)</sup> Lower values are valid up to an ambient temperature of max. 25 °C / 77 °F // <sup>2)</sup> depending on the set point. /// All technical data are specified for units with standard equipment at an ambient temperature of 25 °C and a voltage fluctuation of ±10 %. The temperature data are determined in accordance with factory standard following DIN 12880 respecting the recommended wall clearances of 10 % of the height, width and depth of the inner chamber. All values have been specified at a fan speed of 100%. All indications are average values, typical for units produced in series. We reserve the right to change technical specifications at any time.



► HEATING UP AND COOLING DOWN RATE

**MKF 115**

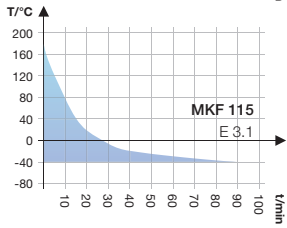
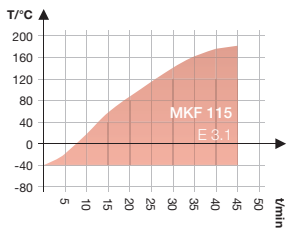

**MKF 240**

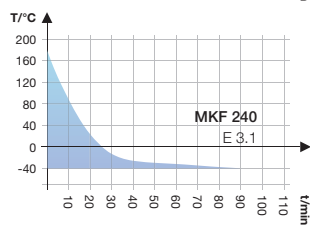
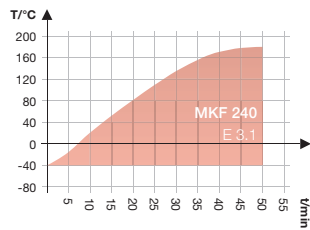

**MKF 720**

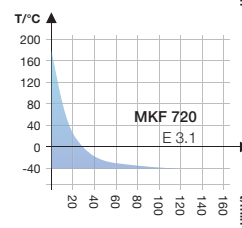
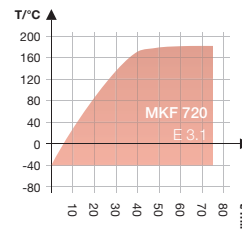

► HEAT COMPENSATION

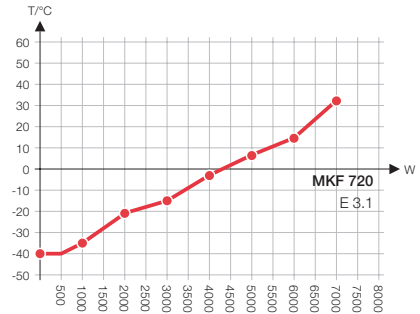
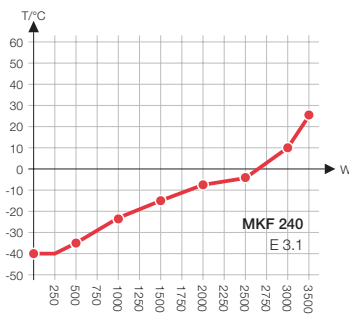
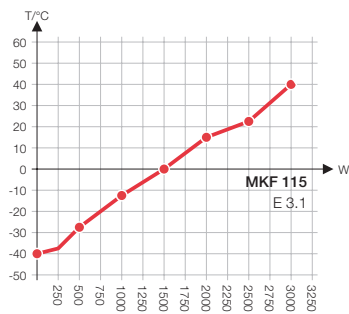

► DIMENSIONS

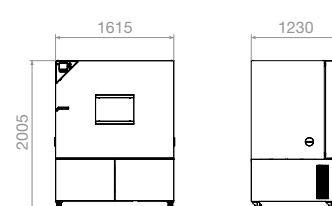
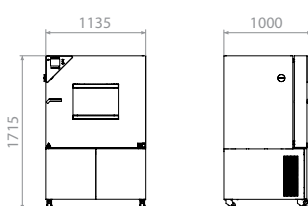
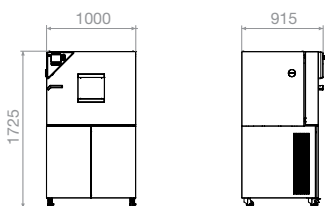

# Technical data for your planning and installation

## MKF series with water cooling



	MKF 115	MKF 240	MKF 720
<b>Exterior dimensions</b>			
Width (mm)	1000	1130	1615
Height (including feet/castors) (mm)	1725	1715	2005
Depth (including door handle, I-panel and exhaust duct) (mm)	915	1000	1230
<b>Interior dimensions</b>			
Width (mm)	600	735	1200
Height (mm)	480	700	1020
Depth (mm)	400	445	600
Interior volume (l)	115	228	734
Quantity of racks (standard/max.)	1 / 4	1 / 6	1 / 11
Load per rack (kg)	30	30	40
Permitted total load (kg)	60	70	160
Weight (empty) (kg)	280	360	590
<b>Temperature data without humidity</b>			
Temperature range (°C) <sup>1)</sup>	-40 – 180	-40 – 180	-40 – 180
Temperature uniformity (± K) <sup>2)</sup>	0.1 – 1.1	0.1 – 1.3	0.1 – 1.8
Temperature fluctuation (± K) <sup>2)</sup>	0.1 – 0.5	0.1 – 0.4	0.1 – 0.5
Mean heating-up rate from -40 °C to 180 °C acc. to factory standard (K/min.)	5.5	5.0	4.8
Mean cooling rate from 180 °C to -40 °C acc. to factory standard (K/min.)	4.8	5.0	4.8
Max. heat compensation (kW)	2.5	2.8	6.5
<b>Climatic data</b>			
Temperature range (°C)	10 – 95	10 – 95	10 – 95
Temperature fluctuation (± K)	0.1 – 1.3	0.1 – 1.3	0.1 – 1.3
Humidity range (% r.H.)	10 – 98	10 – 98	10 – 98
Humidity fluctuation (± % r.H.)	≤ 2.5	≤ 2.5	≤ 2.5
Max. heat compensation to 25 °C / 90% r.H. (kW)	0.4	0.4	1.0
<b>Electrical data</b>			
Housing protection acc. to EN 60529	IP 20	IP 20	IP 20
Nominal voltage (±10%) 50 Hz (V)	400 3 N ~	400 3 N ~	400 3 N ~
Nominal power (kW)	4.5	6.8	11.0
Energy consumption at 25 °C / 60% r.H. (kW) <sup>2)</sup>	1.15	1.30	2.50
Noise level (ca. dB(A))	62	65	65
<b>Model no.</b>	<b>9020-0107</b>	<b>9020-0183</b>	<b>9020-0198</b>
<b>Model no. water cooling</b>	<b>8012-0804</b>	<b>8012-0842</b>	<b>8012-0843</b>

### EXCERPT FROM FULFILLED STANDARDS

DIN EN 60068-2-30:2006-06	DIN EN 61215:2006-02, 10.12
DIN EN 60068-2-38:2010-06	DIN EN 61215:2006-02, 10.13
DIN EN 60068-2-66:1995-06	DIN EN 61646:2009-03, 10.11
DIN EN 60068-2-78:2010-10	DIN EN 61646:2009-03, 10.12
DIN EN 60068-3-5:2002-12	DIN EN 61646:2009-03, 10.13
DIN EN 61215:2006-02, 10.11	MIL STD 810:2000-01

For standards with description, see page 4.

### TEMPERATURE-HUMIDITY CHART

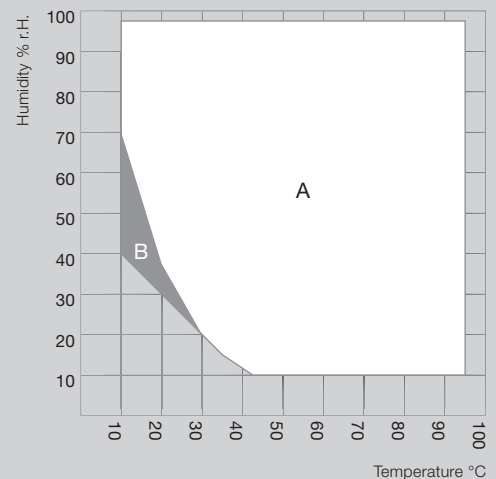

A: Standard Climate range

B: Temporary usable space (up to 24 h)

<sup>1)</sup> Lower values are valid up to an ambient temperature of max. 25 °C / 77 °F // <sup>2)</sup> depending on the set point. /// All technical data are specified for units with standard equipment at an ambient temperature of 25 °C and a voltage fluctuation of ±10 %. The temperature data are determined in accordance with factory standard following DIN 12880 respecting the recommended wall clearances of 10 % of the height, width and depth of the inner chamber. All values have been specified at a fan speed of 100%. All indications are average values, typical for units produced in series. We reserve the right to change technical specifications at any time.



**MKF 115**

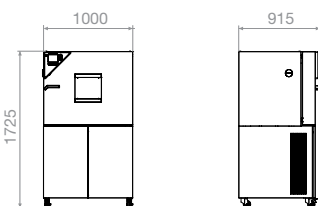
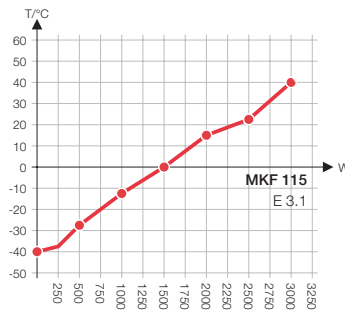
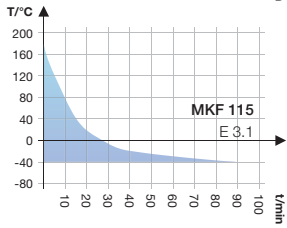
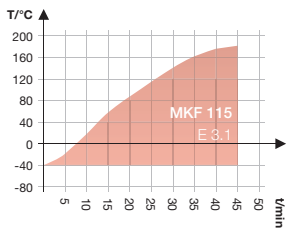

**MKF 240**

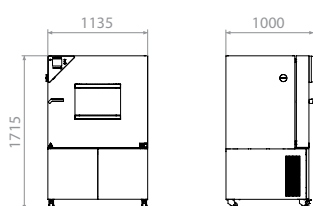
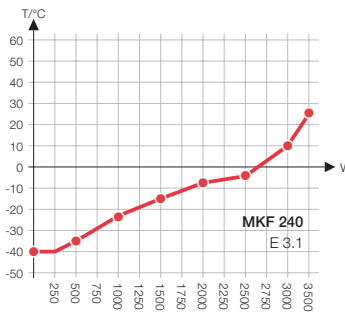
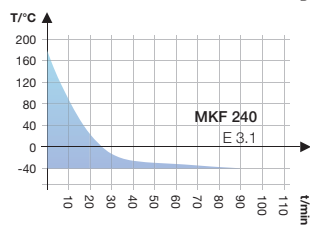
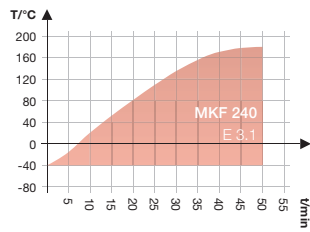

**MKF 720**

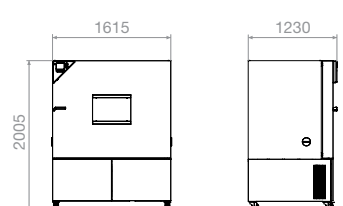
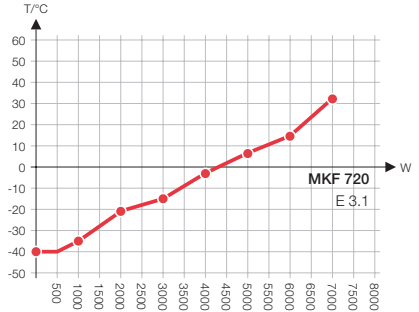
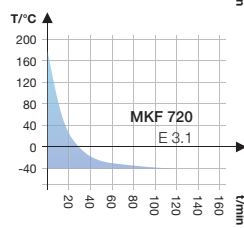
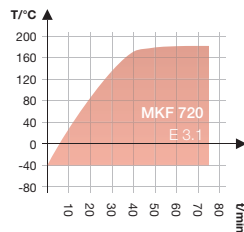

- 1
- 2
- 3
- 4
- 5

# Technical data for your planning and installation

## MKF 720 with regulated compressed-air dryer

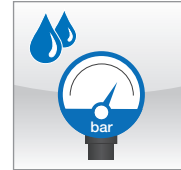

MKF 720	
<b>Exterior dimensions</b>	
Width (mm)	1615
Height (including feet/castors) (mm)	2005
Depth (including door handle, I-panel and exhaust duct) (mm)	1400
<b>Interior dimensions</b>	
Width (mm)	1200
Height (mm)	1020
Depth (mm)	600
Interior volume (l)	734
Quantity of racks (standard/max.)	1 / 11
Load per rack (kg)	40
Permitted total load (kg)	160
Weight (empty) (kg)	605
<b>Temperature data without humidity</b>	
Temperature range (°C) <sup>1)</sup>	-40 – 180
Temperature uniformity (± K) <sup>2)</sup>	0.1 – 1.8
Temperature fluctuation (± K) <sup>2)</sup>	0.1 – 0.5
Mean heating-up rate from -40 °C to 180 °C acc. to factory standard (K/min.)	4.8
Mean cooling rate from 180 °C to -40 °C acc. to factory standard (K/min.)	4.8
Max. heat compensation (kW)	6.5
<b>Climatic data</b>	
Temperature range (°C)	10 – 95
Temperature fluctuation (± K)	0.2 – 1.5
Humidity range (% r.H.)	10 – 98
Humidity fluctuation (± % r.H.)	≤ 2.5
Max. heat compensation to 25 °C / 90% r.H. (kW)	0.5
<b>Compressed-air dryer data</b>	
Standard compressed-air quality (bar)	6 – 8
<b>Electrical data</b>	
Housing protection acc. to EN 60529	IP 20
Nominal voltage (±10%) 50 Hz (V)	400
Nominal power (kW)	11
Energy consumption at 25 °C / 60% r.H. (kW) <sup>2)</sup>	3.9
Noise level without compressed-air dryer (ca. dB(A))	65
Noise level with max. compressed-air dryer (ca. dB(A))	85
<b>Model no. MKF 720</b>	<b>9020–0198</b>
<b>Model no. regulated compressed-air dryer</b>	<b>8012–0751</b>

### EXCERPT FROM FULFILLED STANDARDS

DIN EN 60068-2-30:2006-06	DIN EN 61646:2009-03, 10.11
DIN EN 60068-2-38:2010-06	DIN EN 61646:2009-03, 10.12
DIN EN 60068-2-66:1995-06	DIN EN 61646:2009-03, 10.13
DIN EN 60068-2-78:2010-10	MIL STD 810:2000-01
DIN EN 60068-3-5:2002-12	PV 2500
DIN EN 61215:2006-02, 10.11	PV 1200
DIN EN 61215:2006-02, 10.12	PR 308.1
DIN EN 61215:2006-02, 10.13	

For standards with description, see page 4.  
Other standards on request.

### TEMPERATURE-HUMIDITY CHART

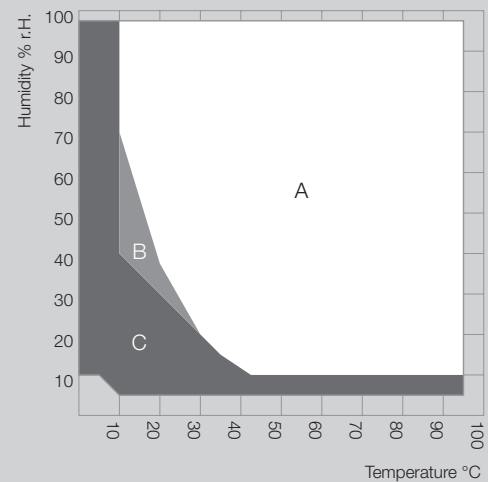

A: Standard Climate range  
B: Temporary usable space (up to 24 h)  
C: Extended range with regulated compressed air-dryer

<sup>1)</sup> Lower values are valid up to an ambient temperature of max. 25 °C / 77 °F // <sup>2)</sup> depending on the set point. /// All technical data are specified for units with standard equipment at an ambient temperature of 25 °C and a voltage fluctuation of ±10%. The temperature data are determined in accordance with factory standard following DIN 12880 respecting the recommended wall clearances of 10% of the height, width and depth of the inner chamber. All values have been specified at a fan speed of 100%. All indications are average values, typical for units produced in series. We reserve the right to change technical specifications at any time.



▶ HEATING UP AND COOLING DOWN RATE

**MKF 720**

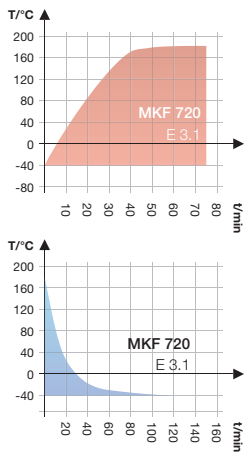

▶ TESTING SCENARIO WITH COMPRESSED-AIR DRYER

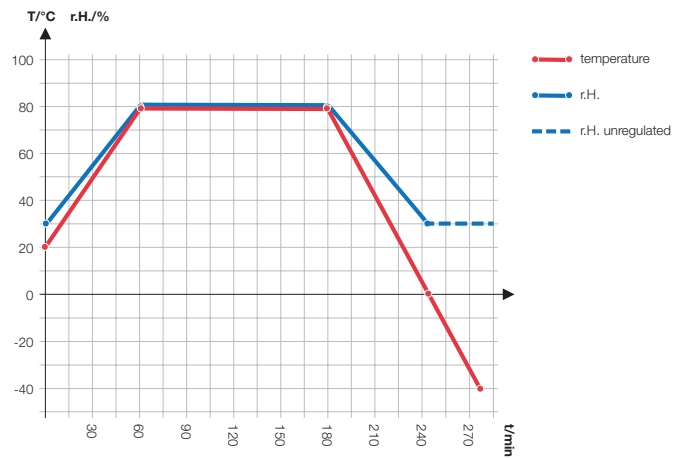

▶ HEAT COMPENSATION

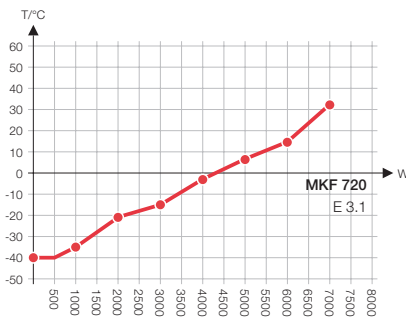

▶ STANDARDIZED OPERATIONS

- ▶ Regulated compressed-air dryer allows highly dynamic humidity changes
- ▶ Particularly well suited for delineating the various standards required by the automotive industry
- ▶ Difficult test scenarios are possible, e.g. 0 °C at 30% r.H.
- ▶ Realization of very low dew points of down to -30 °C
- ▶ Specified humidity values are quickly achieved and accurately maintained

▶ DIMENSIONS

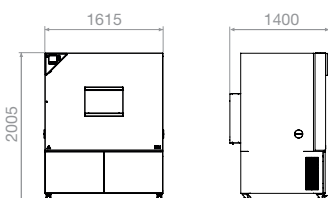

# Technical data for your planning and installation

## MKFT series



	MKFT 115	MKFT 240	MKFT 720
<b>Exterior dimensions</b>			
Width (mm)	1000	1135	1615
Height (including feet/casters) (mm)	1725	1940	2005
Depth (including door handle, I-panel and exhaust duct) (mm)	915	1000	1230
<b>Interior dimensions</b>			
Width (mm)	600	735	1200
Height (mm)	480	700	1020
Depth (mm)	400	445	600
Interior volume (l)	115	228	734
Quantity of racks (standard/max.)	1 / 4	1 / 6	1 / 11
Load per rack (kg)	30	30	40
Permitted total load (kg)	60	70	160
Weight (empty) (kg)	330	415	635
<b>Temperature data without humidity</b>			
Temperature range (°C) <sup>1)</sup>	-70 – 180	-70 – 180	-70 – 180
Temperature uniformity (± K) <sup>2)</sup>	0.1 – 1.3	0.2 – 1.8	0.3 – 2.0
Temperature fluctuation (± K) <sup>2)</sup>	0.1 – 0.5	0.1 – 0.5	0.1 – 0.5
Mean heating-up rate from -40 °C to 180 °C acc. to factory standard (K/min.)	5.5	5.0	4.8
Mean cooling rate from 180 °C to -40 °C acc. to factory standard (K/min.)	4.2	4.2	4.0
Max. heat compensation (kW)	1.5	3.0	5.0
<b>Climatic data</b>			
Temperature range (°C)	10 – 95	10 – 95	10 – 95
Temperature fluctuation (± K)	0.1 – 1.0	0.1 – 1.5	0.1 – 1.0
Humidity range (% r.H.)	10 – 98	10 – 98	10 – 98
Humidity fluctuation (± % r.H.)	≤ 2.5	≤ 2.5	≤ 2.5
Max. heat compensation to 25 °C / 90% r.H. (kW)	0.4	0.4	0.8
<b>Electrical data</b>			
IP protection class acc. to EN 60529	IP 20	IP 20	IP 20
Nominal voltage (±10%) 50 Hz (V)	400 3 N ~	400 3 N ~	400 3 N ~
Nominal power (kW)	6.2	7.5	13.0
Energy consumption at 25 °C / 60% r.H. (kW)	1.25	1.50	2.20
Noise level (ca. dB(A))	62	65	69
<b>Model no.</b>			
	9020-0152	9020-0080	9020-0083

### EXCERPT FROM FULFILLED STANDARDS

DIN EN 60068-2-1:2008-01	DIN EN 61215:2006-02, 10.13
DIN EN 60068-2-2:2008-05	DIN EN 61646:2009-03, 10.11
DIN EN 60068-2-14:2010-09	DIN EN 61646:2009-03, 10.12
DIN EN 60068-2-30:2006-06	DIN EN 61646:2009-03, 10.13
DIN EN 60068-2-38:2010-06	MIL STD 331:2005-01
DIN EN 60068-2-66:1995-06	MIL STD 810:2000-01
DIN EN 60068-2-78:2010-10	BMW PR 303
DIN EN 60068-3-5:2002-12	BMW PR 308
DIN EN 61215:2006-02, 10.11	Porsche PPV 4017
DIN EN 61215:2006-02, 10.12	Porsche PTL 8140

For standards with description, see page 4.

### TEMPERATURE-HUMIDITY CHART

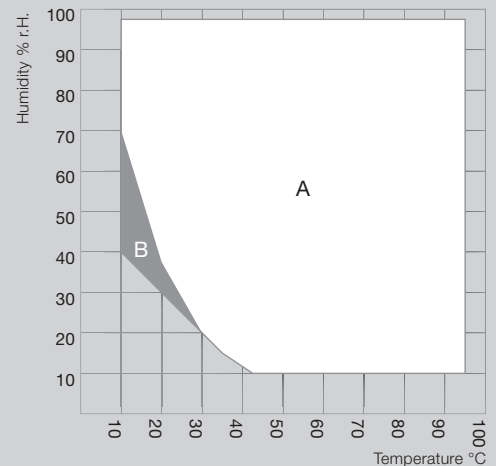

A: Standard Climate range

B: Temporary usable space (up to 24 h)

<sup>1)</sup> Lower values are valid up to an ambient temperature of max. 25 °C / 77 °F // <sup>2)</sup> depending on the set point. /// All technical data are specified for units with standard equipment at an ambient temperature of 25 °C and a voltage fluctuation of ±10 %. The temperature data is determined in accordance to factory standard following DIN 12880, respecting the recommended wall clearances of 10% of the height, width and depth of the inner chamber. All figures are typical average values for series devices. We reserve the right to alter technical specifications at any time.



► HEATING UP AND COOLING DOWN RATE

**MKFT 115**

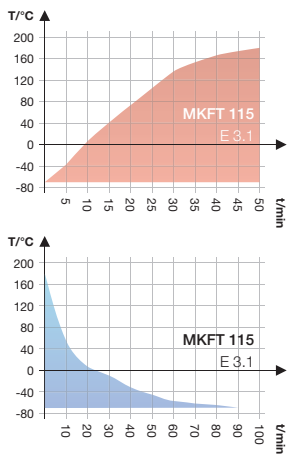

**MKFT 240**

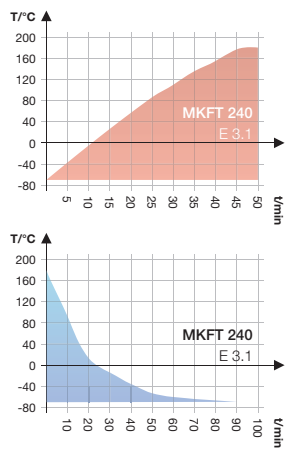

**MKFT 720**

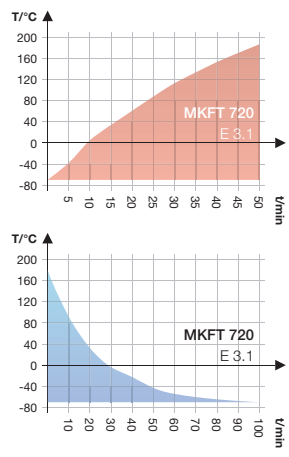

► HEAT COMPENSATION

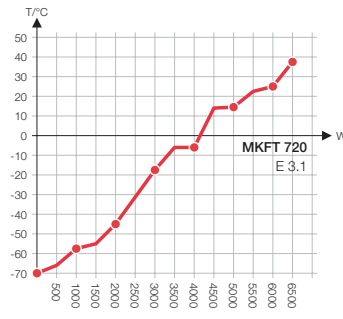
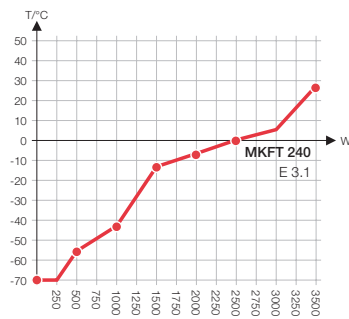
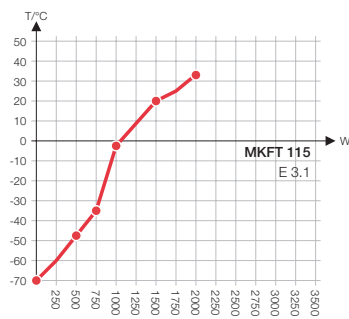

► DIMENSIONS

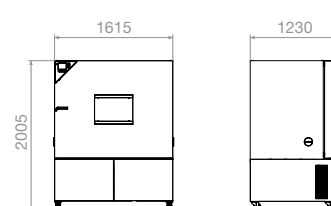
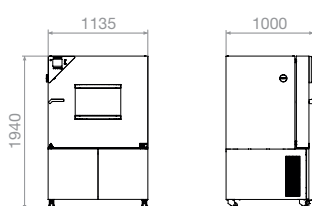
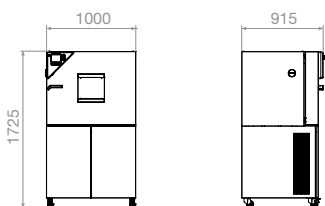

- 1
- 2
- 3
- 4
- 5



**BINDER**

11:31:39 01.07.11 X  
M  
TEMP 85.0 85.0 °C  
HUMID 85.0 85.0 %RH  
HUMID OFF HUMID  
COLE TIC BPL II UTES

EXIT  
ENTER

Five small black buttons

Black handle

# Dynamic constant climate testing

## KMF series

### More options: Dynamic constant climate chambers

- ▶ More flexibility
  - ▶ Temperature range from -10 °C to 100 °C
  - ▶ Broad climate range up to 90% r.H.
  - ▶ Defined temperature change rates
  - ▶ Automatic water and wastewater management
- ▶ More reliability
  - ▶ Responsive vapor pressure humidification
  - ▶ Powerful cooling system for safe operation up to 32 °C ambient temperature
  - ▶ Long-term stress testing, e. g. at 85 °C / 85% r.H.

The dynamic constant climate chambers from BINDER ensure absolutely constant test conditions throughout the testing area. Their greatest advantage is the low space requirement and flexibility regarding the water supply. The wide temperature and humidity ranges make them ideally suited for stress testing series.



Packaging industry



Automotive industry



Solar technology

1

2

3

4

5

# Constant climate chambers for stress testing

## KMF series

The KMF is the specialist for unconditionally reliable stress testing and precise maintenance of constant test conditions. It has particularly large power reserves and an extremely broad climate range: from -10 °C to 100 °C. It works condensation-free up to 90% r.H. These features make the KMF unique in its class.



► KMF 240 model

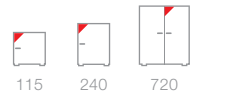

115 240 720

Available sizes (liters)

### ► EQUIPMENT

- Temperature range from -10 °C to 100 °C
- Humidity range 10 % to 90% r.H.
- MCS controller which can store 25 programs of 100 sections each for a maximum of 500 program segments
- User-friendly LCD color screen
- Easy-to-read menu guide
- Integrated electronic chart recorder
- Variety of options for the graphic display of process parameters
- Real-time clock
- Electronically controlled humidification and dehumidification system with capacitive humidity sensor
- Inner glass door
- Independent temperature safety device class 3.1 (DIN 12880) with visual and audible alarm
- Access port with silicone plug Ø 30 mm, left side
- Complete safety connection kit for water supply and drainage, up to 1m in height
- Ethernet interface for communication software APT-COM™ DataControlSystem
- Shelf, stainless steel
- Four casters, two with brakes (KMF 240/720)



► **KMF SERIES | BEST TEST CONDITIONS:**

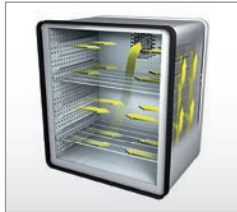

**Precise climate conditions**

- BINDER APT.line™ preheating chamber
- Constant and gentle circulation of air through large-surface side walls even under a full load
- Homogeneous climate conditions throughout test specimens



**Flexible water management**

- Sewage pump for discharges up to 1m in height
- Solutions independent of installation sight
- Water treatment with BINDER PURE AQUA SERVICE
- External water supply



**Fast and precise humidification**

- Vapor pressure humidification with fast response times
- Drift-free, capacitive humidity sensor
- Short recovery times after door opening
- Finely adjustable humidity control



**Comprehensive additional services**

- Data Logger Kits
- Years of proven validation and documentation materials
- Customer-specific modifications



**Convenient assembly and operation**

- Large access area
- Control elements accessible from the front
- Optimal ratio of usable space and footprint

► **OPTIONS**

- Access ports of various diameters with silicone plug
- Shelf, stainless steel
- Perforated shelf, stainless steel
- Reinforced rack, stainless steel
- Lockable controller keyboard
- Interior lighting
- Additional PT 100 temperature sensor
- RS 422 interface
- External water supply set
- BINDER PURE AQUA SERVICE
- Calibration certificate and extension to calibration certificate
- Measurement of temperature accuracy according to DIN 12880
- Data Logger Kit and software
- Independent temperature safety device class 3.3 (DIN 12880)
- Analog outputs 4 – 20 mA for temperature and humidity measurements
- Door lock



**BINDER PURE AQUA SERVICE**



**Data Logger Kits**



**Numerous access ports**



**Climate chamber with windows, doors and access ports for connecting several measuring instruments**

**BINDER INDIVIDUAL**  
More information from page 90

# Technical data for your planning and installation

## KMF series



	KMF 115	KMF 240	KMF 720
<b>Exterior dimensions</b>			
Width (including access port) (mm)	885	930	1255
Height (including feet/castors) (mm)	1050	1460	1925
Depth (including door handle, I-panel and exhaust duct) (mm)	730	880	970
<b>Interior dimensions</b>			
Width (mm)	600	650	975
Height (mm)	485	785	1250
Depth (mm)	350	485	575
Interior volume (l)	102	247	700
Quantity of racks (standard/max.)	1 / 5	1 / 9	1 / 15
Load per rack (kg)	30	30	45
Permitted total load (kg)	100	100	150
Weight (empty) (kg)	127	185	309
<b>Temperature data</b>			
Temperature range (°C) <sup>1)</sup>	-10 – 100	-10 – 100	-10 – 100
Average heating up time acc. to IEC 60068-3-5 (K/min.)	1.3	1.1	1.0
Average cooling down time acc. to IEC 60068-3-5 (K/min.)	0.5	0.6	0.4
Max. heat compensation up to 25 °C (kW)	0.15	0.3	0.4
<b>Climatic data</b>			
Temperature range (°C) <sup>1)</sup>	10 – 90	10 – 90	10 – 90
Temperature uniformity (± K) <sup>2)</sup>	0.3 – 1.0	0.1 – 1.0	0.2 – 1.0
Temperature fluctuation (± K) <sup>2)</sup>	0.1 – 0.2	0.1 – 0.4	0.1 – 0.5
Humidity range (% r.H.)	10 – 90	10 – 90	10 – 90
Humidity fluctuation (± % r.H.) <sup>2)</sup>	≤ 2.5	≤ 2.0	≤ 2.0
<b>Electrical data</b>			
IP protection class acc. to EN 60529	IP 20	IP 20	IP 20
Nominal voltage (±10%) 50 Hz (V)	200 – 240 1 N ~	200 – 240 1 N ~	200 – 240 1 N ~
Nominal power (kW)	2.0	2.5	3.1
Energy consumption at 85 °C / 85% r.H. (kW)	0.57	0.72	1.05
Noise level (ca. dB(A))	52	52	53
<b>Model no.</b>			
	9020-0187	9020-0219	9020-0245

► TEMPERATURE-HUMIDITY CHART

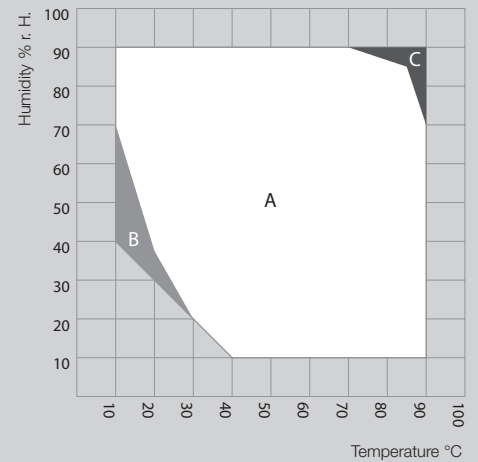

- A: Guaranteed condensation-free range
- B: Time-limited operation (max. 24 hours)
- C: Condensation in the inner chamber may be possible

<sup>1)</sup> Lower values are valid up to an ambient temperature of max. 25 °C / 77 °F // <sup>2)</sup> depending on the set point /// All technical data are specified for units with standard equipment at an ambient temperature of 25 °C and a voltage fluctuation of ±10 %. The temperature data are determined in accordance with factory standard following DIN 12880 respecting the recommended wall clearances of 10 % of the height, width and depth of the inner chamber. Technical data refers to 100 % fan speed. All indications are average values, typical for units produced in series. We reserve the right to change technical specifications at any time.



► HEATING UP RATE AND COOLING DOWN RATE

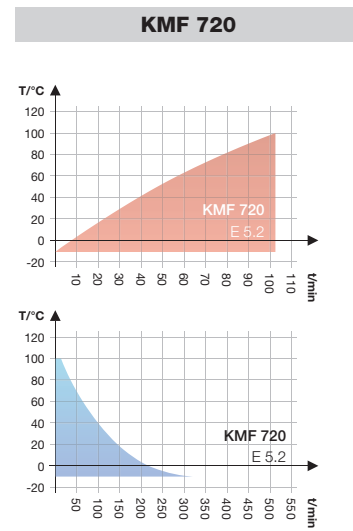
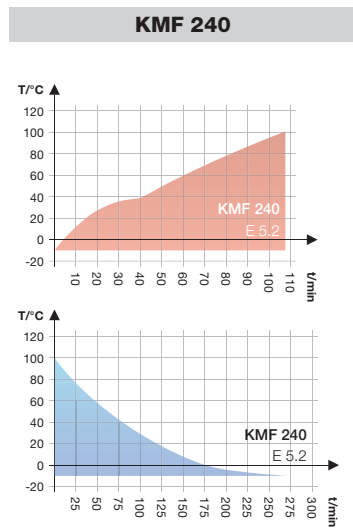
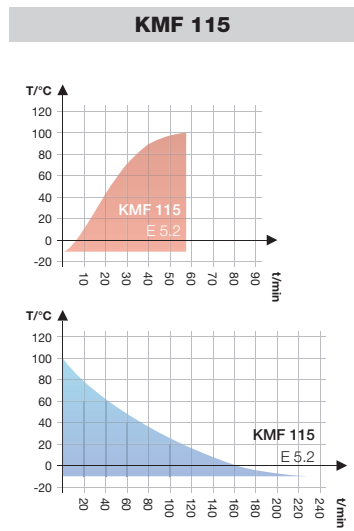

► HEAT COMPENSATION

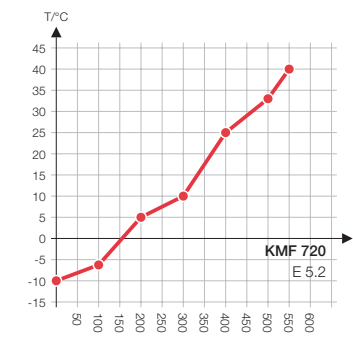
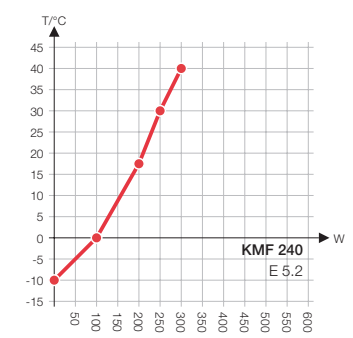
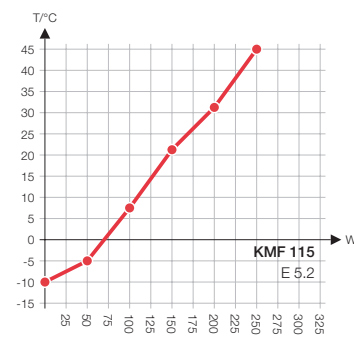

► DIMENSIONS

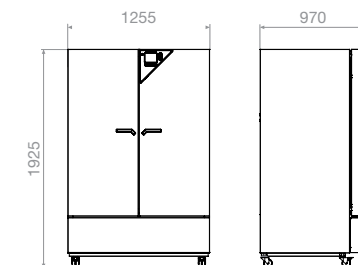
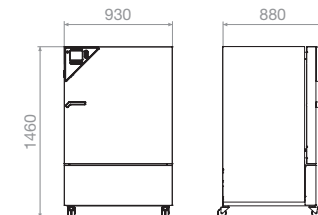
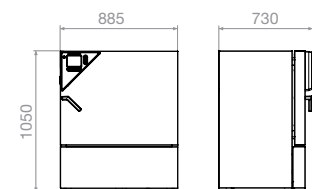

- 1
- 2
- 3
- 4
- 5



BINDER

BIN

37.0  
5.0

# APT-COM™ Communication software

## | APT-COM™ DataControlSystem

Working in compliance with standards always requires excellent documentation. APT-COM™ resulted in standard software with a uniquely universal capability: Users can easily achieve process safety and data security, as well as validation of the entire system using standard features. Easy. Cutting edge.

The system, which consists of software in three different editions and the connected equipment, offers features that are needed for tasks ranging from the simplest measurements to guideline-compliant work: seamless monitoring of processes and documentation of process data. Documentation is automatically generated in electronic format and as a hard copy. This produces guideline-compliant documentation without extra effort, just like having a tailor-made suit for every PC user. Easy to use for a broad range of applications.



# APT-COM™ DataControlSystem

► **BINDER control and documentation system**

► **Performance potential in 3 classes**

The motto here is not “as much as possible”, but rather “as much as necessary”. This has less to do with the ever-present pressure to reduce costs, and much more to do with the fact that processes today have to be as efficient as possible to achieve the best results. This includes a software system that can meet the individual requirements of a multitude of different tests and users, all while maintaining optimal adaptability. This is the reason why we developed three different comprehensive versions of the APT-COM™ software:

## BASIC

permits remote adjustment of test parameters for the connected equipment, graphic interface programming, and manual documentation of your data.

## STANDARD

links up several units within a network and provides automatic documentation if required.

## GLP-Edition

For the highest demands we provide maximum functionality. Most regulatory requirements are met in this area in no time at all. Another strength of this version is remote alerts for limit violations or communication problems by means of independent monitoring and alert functions.

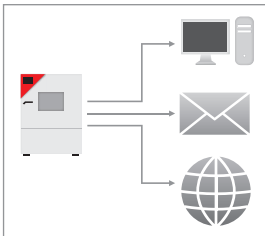

► **Clear presentation of process data**

**Always up-to-date:** Process data can be constantly accessed everywhere: either locally, by email, or through the Internet.

**Important information always available at a glance:** Making a decision on whether or not a process is running well is easy, thanks to the control console function.

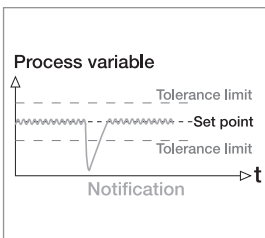

► **Unsurpassed process safety and security**

**Tolerance limits for each monitored parameter:** No parameter can exceed the specified tolerance limits without setting off an automatic alert. The alert is sent via an intranet, the Internet, as email, or as a phone call to the person responsible.

**Access restriction** User IDs and passwords control access to sensitive processes. Different levels of authorization for system changes ensure proper system administration.

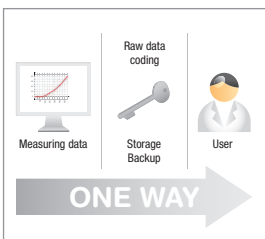

► **Guideline-compliant data security**

**Storage of measured data:** Protected against manipulation by an encrypted format, access restricted to the author or the administrator.

**Backup of measured data:** Automatic backup at user-defined time intervals for storage on all available storage media. Backed up information is easy to find thanks to automatic naming of the backup with a time-stamp.

**Documentation of operator interventions:** Complete documentation of any operator interventions, with user ID, time-stamp, archived protected against manipulation, and automatic backup of measured data.

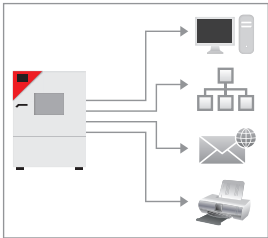
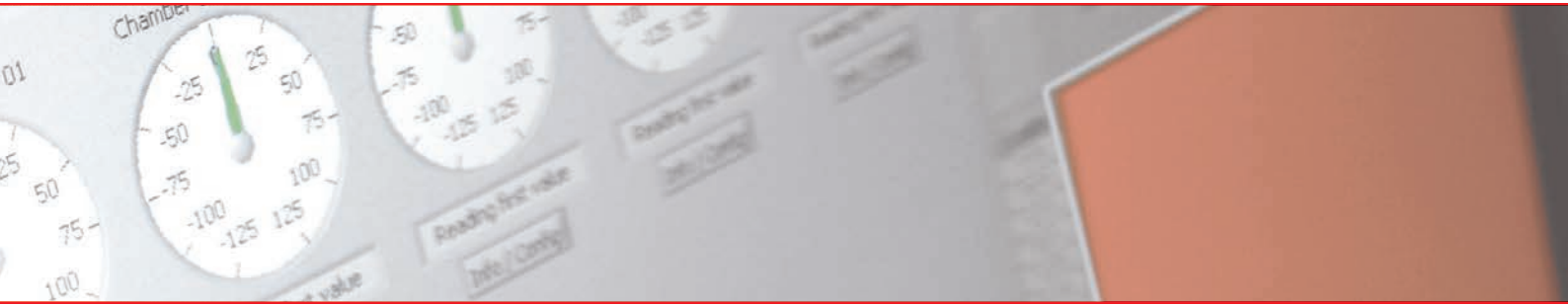

► **Time-saving documentation and presentation of results**

**Generation of measured data on the monitor:** Measured data is constantly regenerated from protected raw data and protected against manipulation.

**Display of measured data on the internet:** Users can access the process sequence with a standard browser on any PC connected to an intranet or the Internet, even without the APT-COM™ software.

**Coordinated file archiving:** Enables quick and easy display and printing of any past test runs.

**Clear printouts:** The measured data can be printed out automatically at adjustable time intervals. Form fields for comments with respect to the measurements and for authentication ensure correct data assignment and coordination. Signature fields and page numbering provide an easy way to meet documentation requirements with minimum effort.

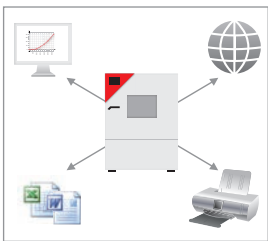

► **Control and programming**

**Remote monitoring of setpoints over great distances:** Equipment isn't always within close proximity of the workstation. This is why we have provided the option of transmitting process variables to the equipment via PC and reviewing equipment settings.

**Graphic program editor:** Facilitates the easy generation of extensive programs, which can be reviewed and transferred to different units. This saves time and increases transparency.



► **System qualification**

**Qualification folders with records for IQ and OQ:** Customized for the actual equipment and software configuration. Facilitates system validation, enjoys an excellent reputation among auditors, and saves time when implementing systems. Together with equipment qualification, it is a complete solution that takes full advantage of our experience.

**System qualification:** Our highly experienced BINDER service technicians supervise the proper commissioning and functionality of the system on site, and document these inspections in IQ/OQ protocols. The documentation of these important qualification steps is a comprehensive, time-saving service to ensure successful qualification.

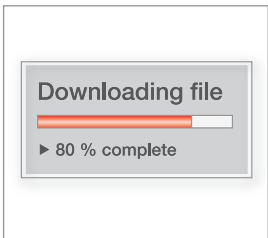

► **Always state-of-the-art with updates**

**Software updates without added costs:** It goes without saying that our software is constantly being improved and updated. In addition to adding new equipment models, we also incorporate new guidelines and customer suggestions for improvements. Updates are available for free download from the BINDER website. Qualification documents are available for every version of the software.

1

2

3

4

5



**BINDER**  
Best conditions for your success

**BINDER**

# BINDER INDIVIDUAL

## | Customized solutions for customized requirements

Special applications sometimes require a special solution. Precisely for this reason, BINDER has created the BINDER INDIVIDUAL division. The implemented solutions in this division are very diverse: stainless steel housings and individual access ports are just the tip of the iceberg.

In many cases, special projects require more technical know-how: for example, some customers have particularly heavy specimens that can't be stored in a conventional chamber, while others need a unit with a particulate filter. We have already successfully mastered countless tasks for a wide range of requirements. This is the same for what particular features should distinguish your future BINDER chamber: BINDER INDIVIDUAL will implement them.

# BINDER INDIVIDUAL

## The customer is the focus

Special applications sometimes require special solutions. BINDER launched BINDER INDIVIDUAL precisely for this reason. There are many solutions already implemented in this area. Stainless steel housings and individual access ports are just the tip of the iceberg. More technical know-how is often required. For example, some customers have particularly heavy specimens that can't be stored in a conventional chamber, while others need a unit with a particulate filter. In countless projects over the years we have found successful solutions for the most diverse applications, regardless of the specific features your future BINDER chamber requires, BINDER INDIVIDUAL can implement it.



► **Services**

- Customized optimization of heat, refrigeration, humidity, light, air, CO<sub>2</sub>, or O<sub>2</sub> supply
- Specific measurement, management, control and switching
- Connections, outputs, extensions and modifications
- Design from parameters
- Customized integration of accessories (e.g. rollers)



► **Service**

- Individual consultation
- Effective planning
- Comprehensive application support

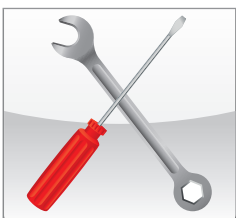

► **Guarantee**

- All components from a single source
- Compliance with ISO 9001 standards
- Guarantee on all customized solutions
- Operating instruction for the expanded scope
- Guarantee on spare parts inventory for 10 years
- Individual identification to ensure that any spare parts for your customized application are provided correctly and promptly

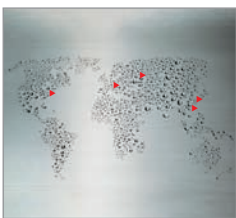

► **Contact**

Phone: +49 (0) 74 62 20 05-0  
 Fax: +49 (0) 74 62 20 05-100  
 E-Mail: [BINDER.INDIVIDUAL@binder-world.com](mailto:BINDER.INDIVIDUAL@binder-world.com)

# Example of a BINDER INDIVIDUAL solution

## Material test chamber FP 115 at UL-TTC

### UL TTC offers service from one source

The leading international supplier for compounding, test specimen production and testing and certification of innovative plastics has relied on material test chambers from BINDER GmbH for years. The accredited testing center headquartered in Krefeld-Uerdingen, Germany, conducts over 200 test procedures on standard and high-performance plastics for a wide range of applications. Fully automatic injection molding machines are used for the specimen forms, where about 100 different test specimen forms are used.



Testing around the clock

### ► REQUIREMENTS

#### UL INTERNATIONAL TTC GMBH (UL-TTC)

- Testing of compound in accordance to continuance and feature
- Testing and certification of innovative plastics
- Accurate temperature throughout the chamber interior in accordance to a defined high air exchange rate
- High reliability – 365 days a year, storage times up to 7,000 hours
- Test requirements in accordance with ISO, ASTM, UL and CAMPUS
- Easy to use
- Clear documentation of the test results

### ► BINDER SOLUTIONS

- Material test bench, elastomer mechanical convection test chamber based on the FP 115
- Homogeneous temperature conditions
- Calibration of temperature as well as air exchange rate simplified and increase in accuracy
- Digital documentation of temperature, unit status (ON/OFF) and error messages



- Device on the exhaust pipe to attach a customer's anemometer



- Inner chamber with 6 perforated racks and central injection fan

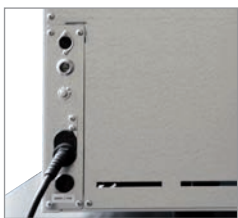

- Potential-free contact for ON/OFF fault messages and contact for object temperature sensor on the back

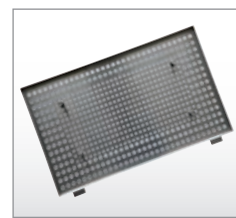

- Perforated rack with locking brackets for PT 100 sensors

1

2

3

4

5

# BINDER INDIVIDUAL

## Customer-specific requirements



### Drying oven

- ▶ With access port in the door and black inner chamber



### Environmental simulation chamber

- ▶ With reinforced base



### Safety drying oven

- ▶ With infrared temperature sensor



### Temperature test chamber

- ▶ With external fan



### Vacuum drying oven

- ▶ With special racks for large numbers of particularly flat samples



### Environmental simulation chamber

- ▶ With CO<sub>2</sub> regulation



### Heating chamber

- ▶ With carrying frame



### Heating chamber

- ▶ With multiple access ports on the back



### Vacuum drying oven

- ▶ With custom-made front panel for additional protection against gas leakage



### Heating chamber

- ▶ With a special extension for loading without opening the door



**Vacuum drying oven**

- ▶ Glove box



**Constant climate chamber**

- ▶ With additional windows, doors and access ports to accommodate the various instrument connection leads

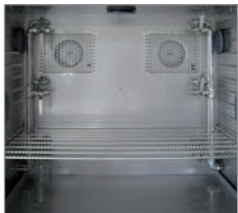

**Environmental simulation chamber**

- ▶ With refrigerant lines and extra access ports



**Drying oven**

- ▶ With subdivided interior and hangers in guide rails for tubing



**Drying oven**

- ▶ Integrated in a conveyor operation



**Constant climate chamber**

- ▶ With full-view glass door and hand access ports



**Environmental simulation chamber**

- ▶ With illumination cassettes



**Material test chamber**

- ▶ With special racks and modified airflow



**Temperature test chamber**

- ▶ With electrical door lock

1

2

3

4

5



Архангельск (8182)63-90-72  
Астана +7(7172)727-132  
Белгород (4722)40-23-64  
Брянск (4832)59-03-52  
Владивосток (423)249-28-31  
Волгоград (844)278-03-48  
Вологда (8172)26-41-59  
Воронеж (473)204-51-73  
Екатеринбург (343)384-55-89  
Иваново (4932)77-34-06  
Ижевск (3412)26-03-58  
Казань (843)206-01-48

Калининград (4012)72-03-81  
Калуга (4842)92-23-67  
Кемерово (3842)65-04-62  
Киров (8332)68-02-04  
Краснодар (861)203-40-90  
Красноярск (391)204-63-61  
Курск (4712)77-13-04  
Липецк (4742)52-20-81  
Магнитогорск (3519)55-03-13  
Москва (495)268-04-70  
Мурманск (8152)59-64-93  
Набережные Челны (8552)20-53-41

Нижний Новгород (831)429-08-12  
Новокузнецк (3843)20-46-81  
Новосибирск (383)227-86-73  
Орел (4862)44-53-42  
Оренбург (3532)37-68-04  
Пенза (8412)22-31-16  
Пермь (342)205-81-47  
Ростов-на-Дону (863)308-18-15  
Рязань (4912)46-61-64  
Самара (846)206-03-16  
Санкт-Петербург (812)309-46-40  
Саратов (845)249-38-78

Смоленск (4812)29-41-54  
Сочи (862)225-72-31  
Ставрополь (8652)20-65-13  
Тверь (4822)63-31-35  
Томск (3822)98-41-53  
Тула (4872)74-02-29  
Тюмень (3452)66-21-18  
Ульяновск (8422)24-23-59  
Уфа (347)229-48-12  
Челябинск (351)202-03-61  
Череповец (8202)49-02-64  
Ярославль (4852)69-52-93